

 Les points

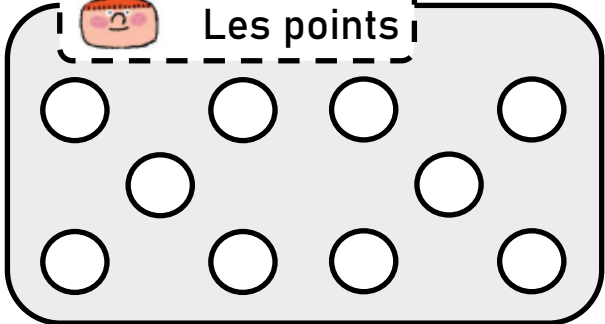

 Les doigts



La boîte de 10

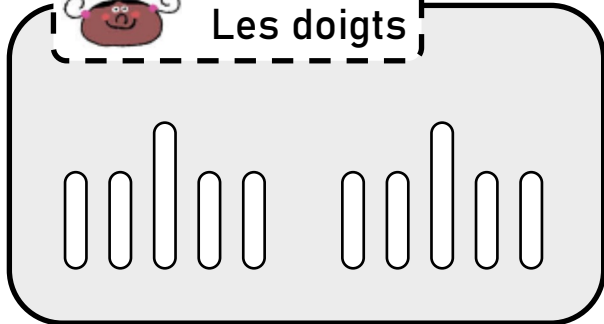
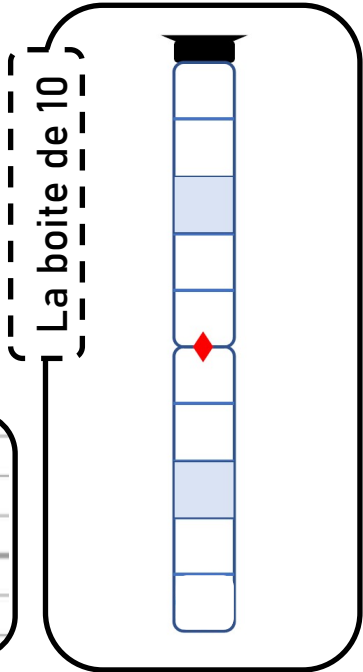

1, 2, 3, ...

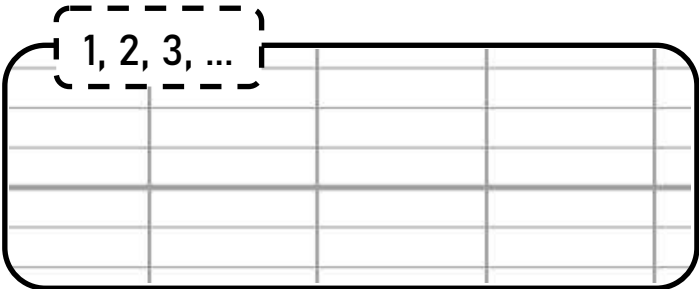

a, b, c, ...

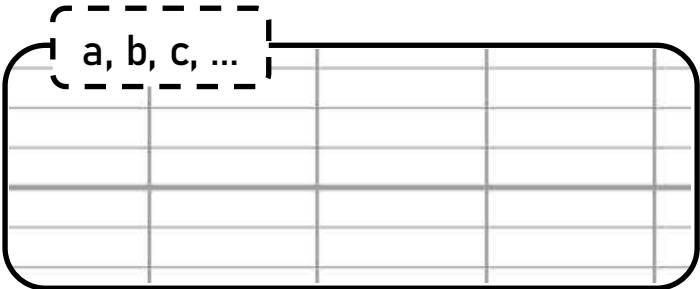

www.fabricole.fr

0 10

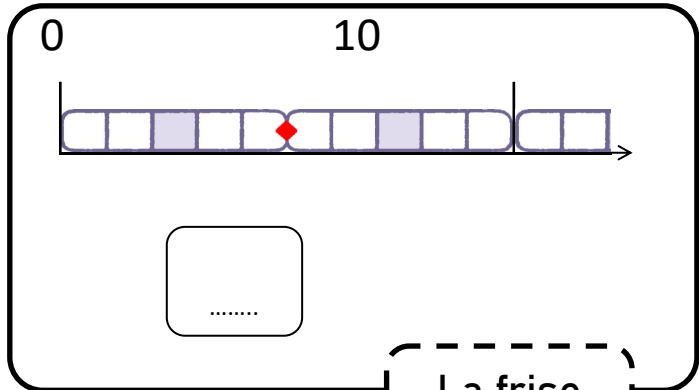

.....

La frise

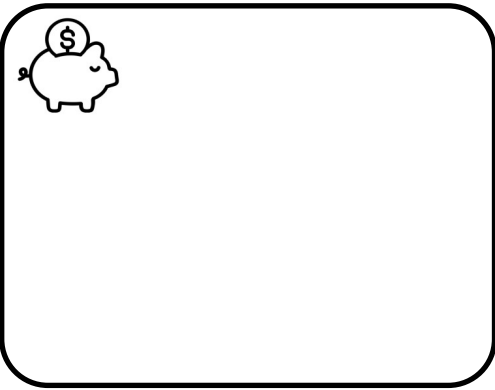
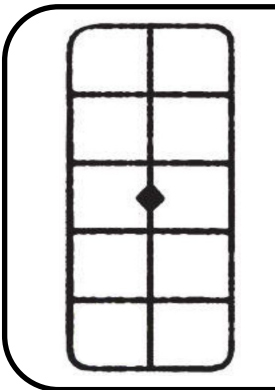
Pair

Impair

Groupement par 2

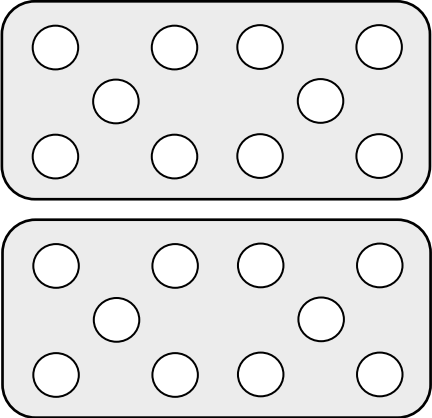
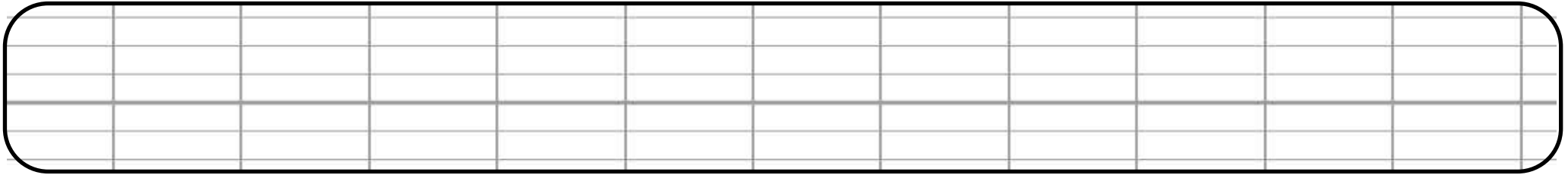

Les points

www.fabricole.fr

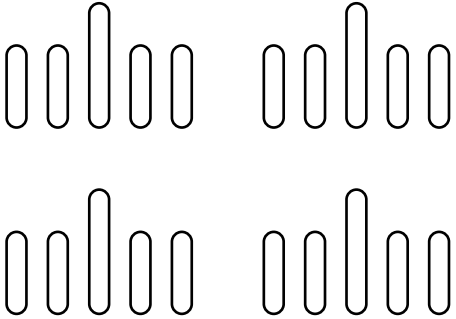



Les doigts

1, 2, 3, ...

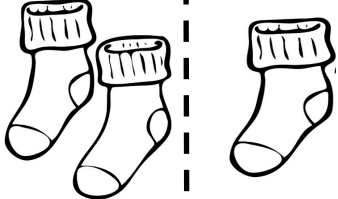
a, b, c, ...

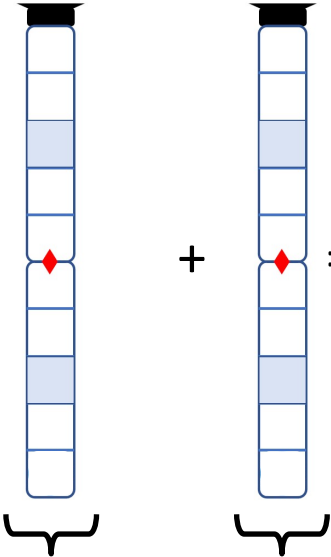

Pair ou impair



+ =

..... + =

Les boites de 10

0 10 20



.....

La frise

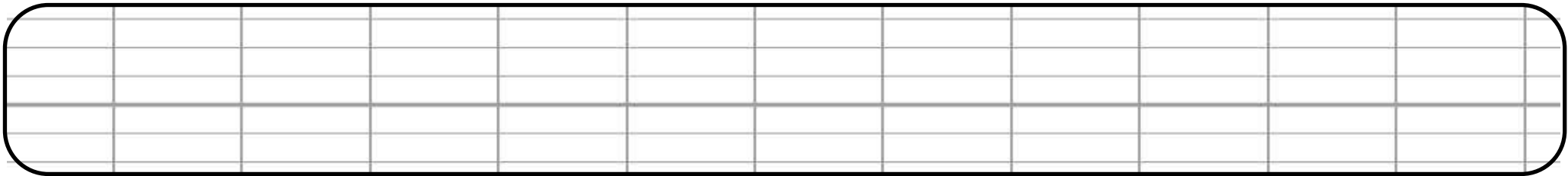

a, b, c, ...

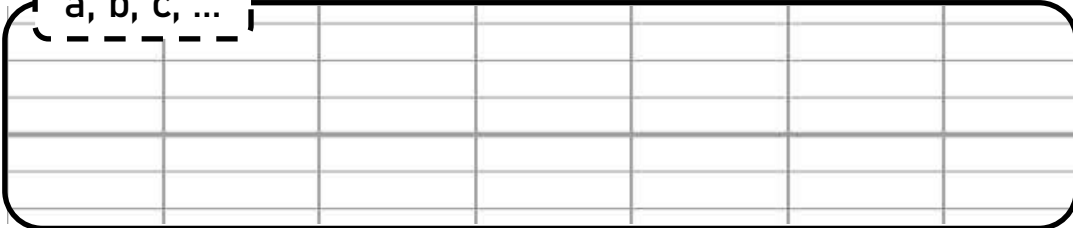

Les boîtes de 10

www.fabricole.fr

..... + =

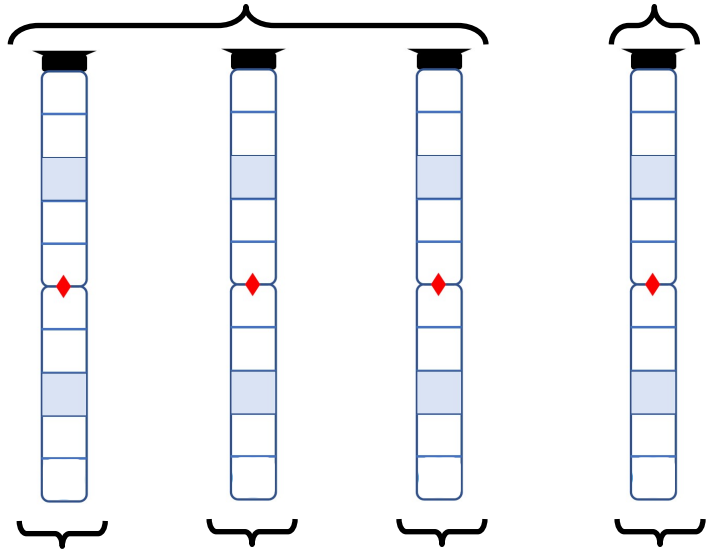

..... + + + =

Pair ou impair

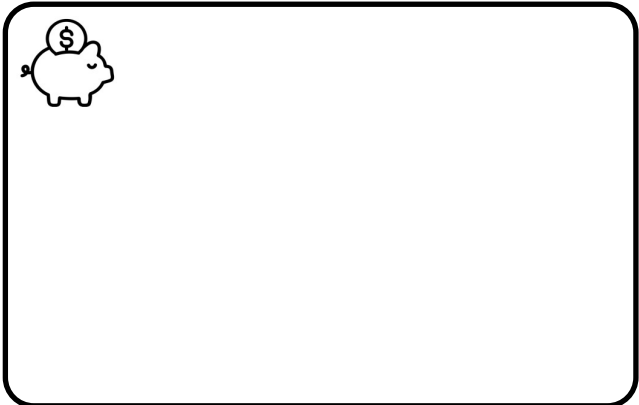
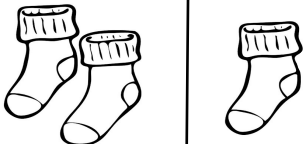

Dizaines Unités

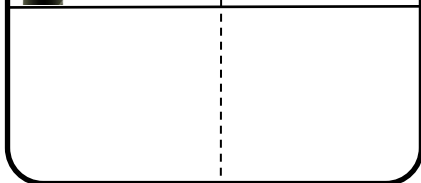

..... < <



La frise



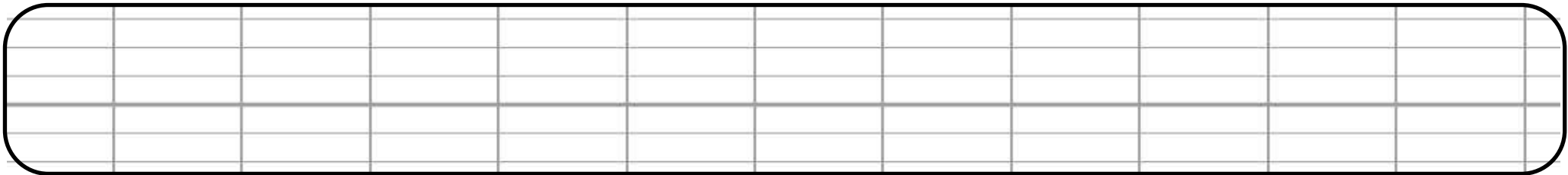

a, b, c, ...

www.fabricole.fr

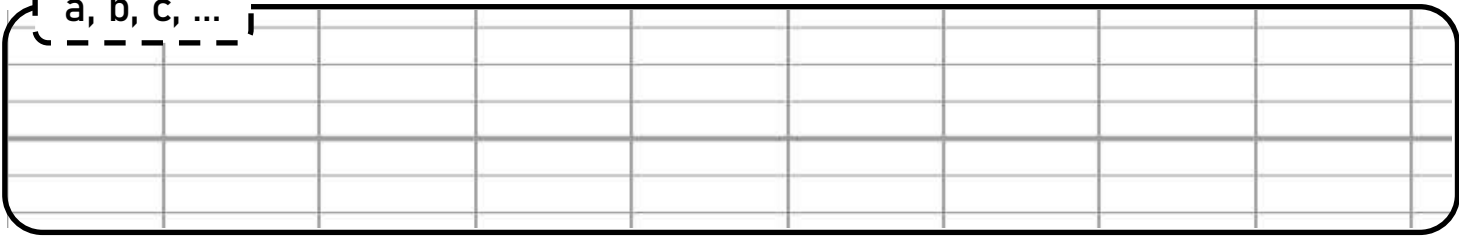

Les boîtes de 10

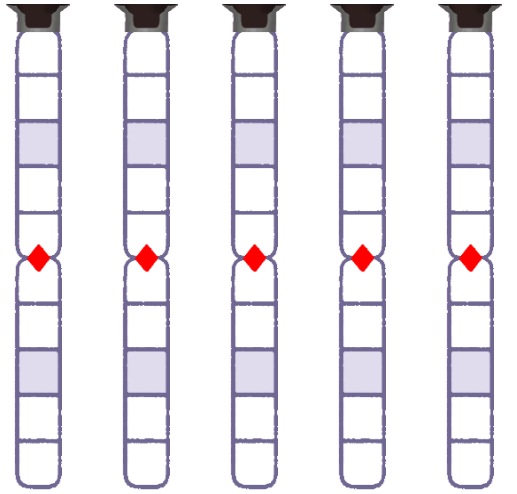

Pair ou impair



Dizaines



Unités

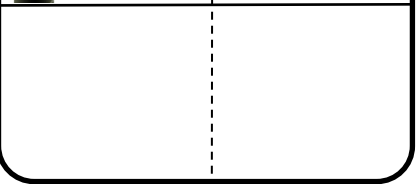

..... = +

..... =

Les décompositions

..... < <

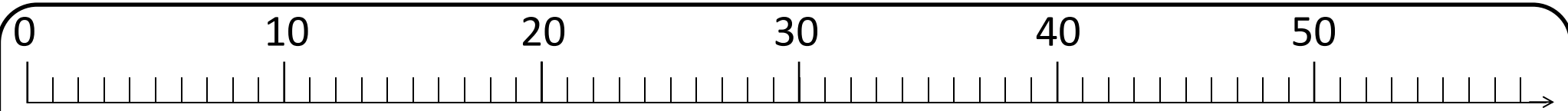

La frise



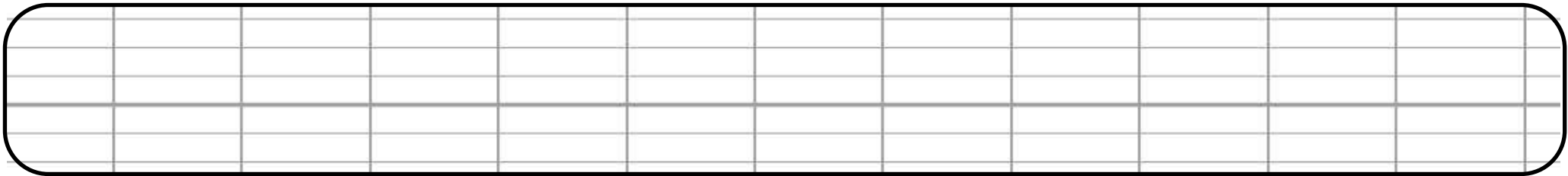

www.fabricole.fr

a, b, c, ...

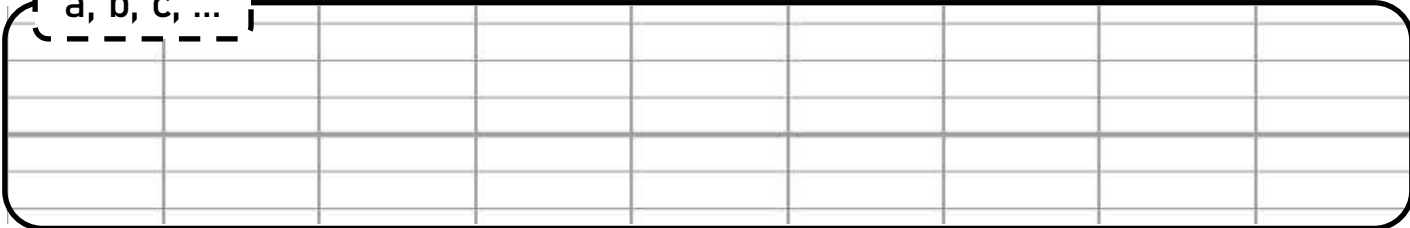

Le tableau des nombres

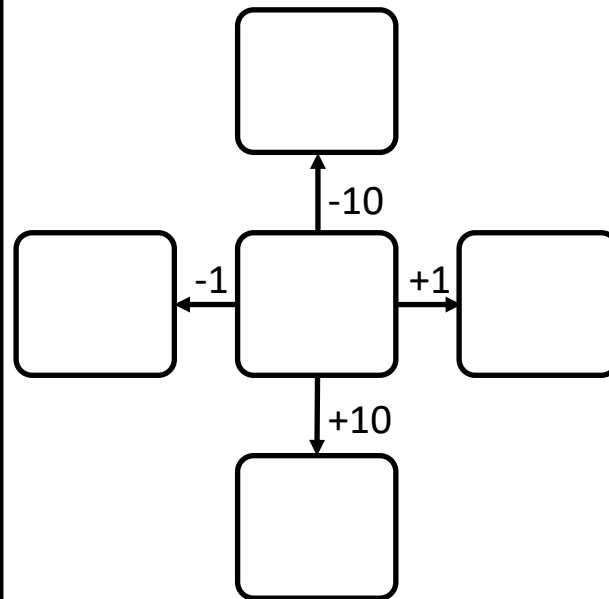

Dizaines



Unités

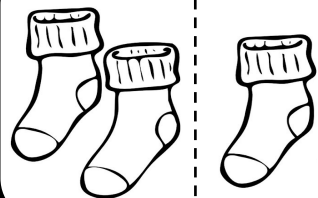

..... = +

..... < <

0 10 20 30 40 50 60 70 80 90 100 110

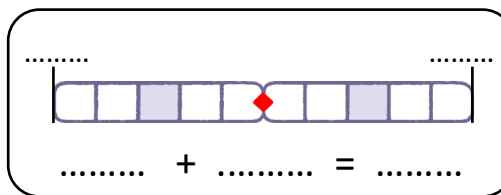
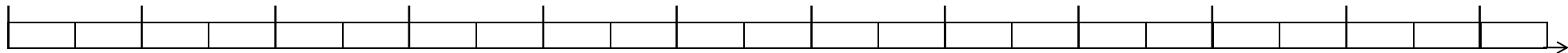

La frise

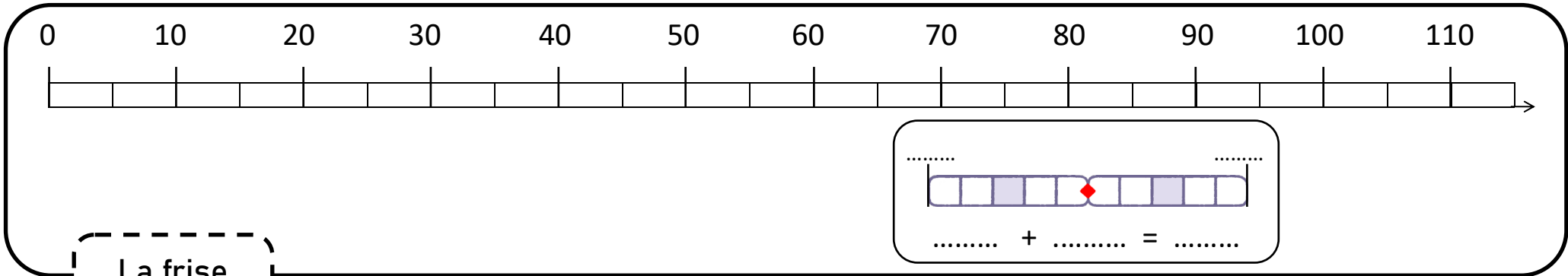

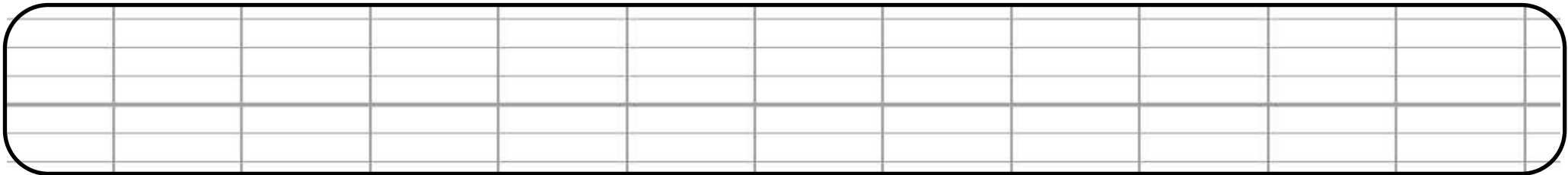

www.fabricole.fr

a, b, c, ...

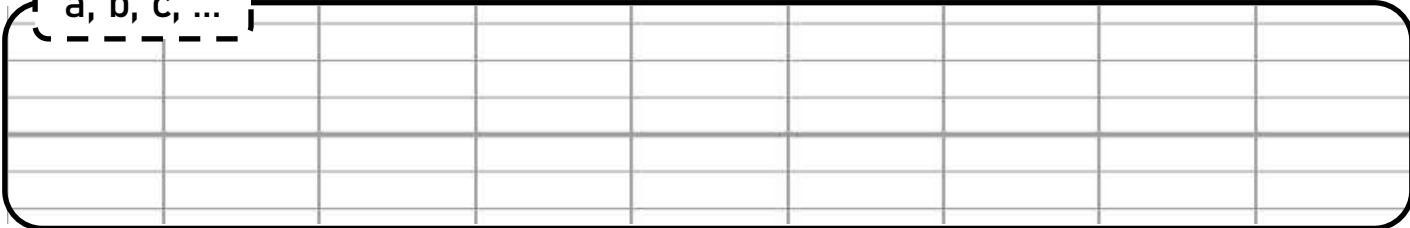

Le tableau des nombres

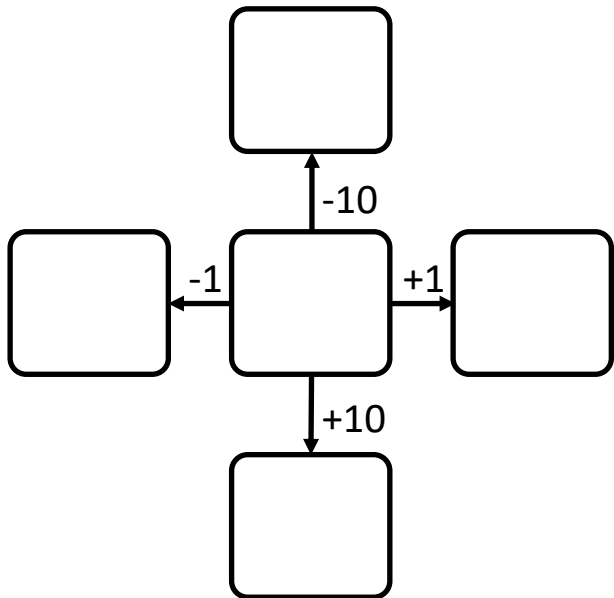

Dizaines Unités

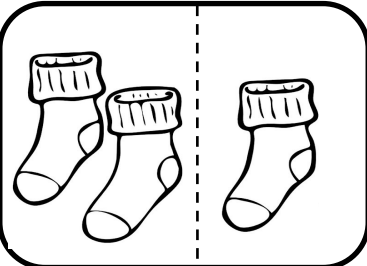

..... = +

..... < <

0 10 20 30 40 50 60 70 80 90 100 110 120 130 140 150

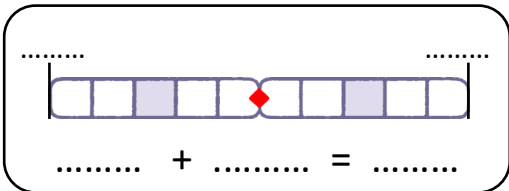
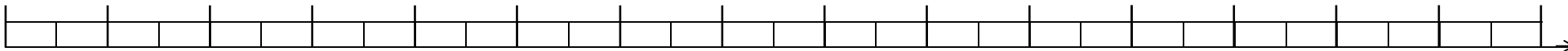

La frise

