

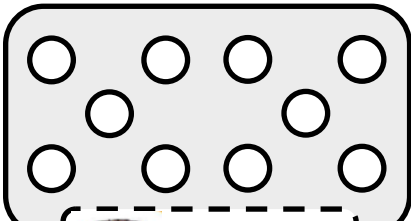

C'est notre premier jour de classe



Les points



Les doigts

La boîte de 10

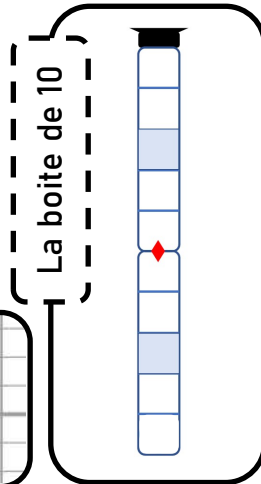

1 un

0 10

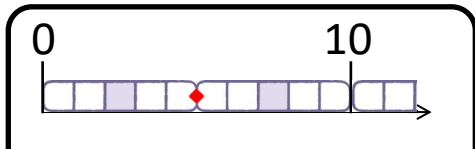

.....

www.fabricole.fr

La frise

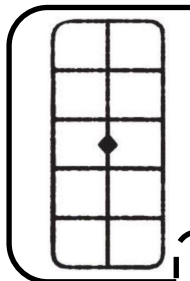
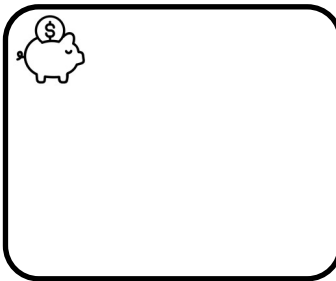

Pair Impair

Groupement par 2

C'est notre deuxième jour de classe

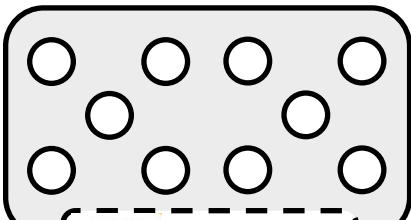

Les points

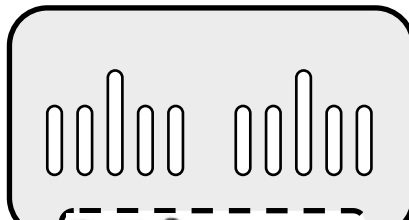

Les doigts

La boîte de 10

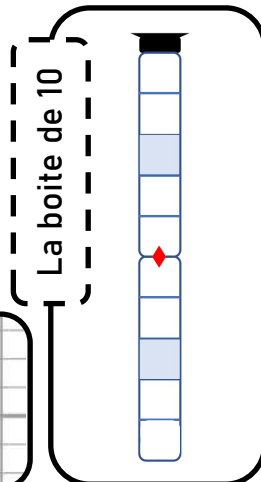

2 deux

0 10

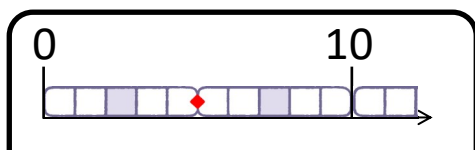

.....

www.fabricole.fr

La frise

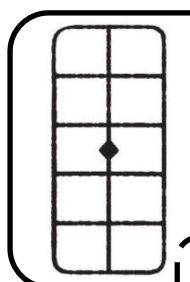
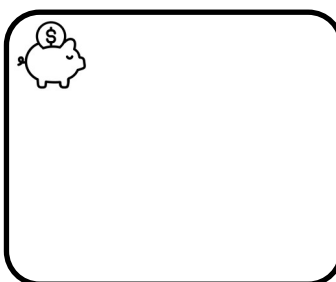

Pair Impair

Groupement par 2

C'est notre troisième jour de classe

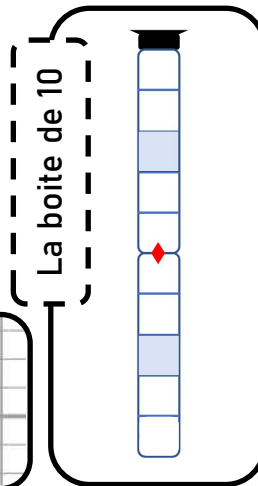
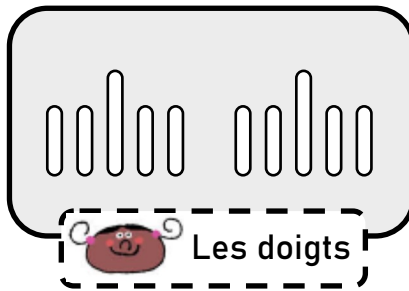
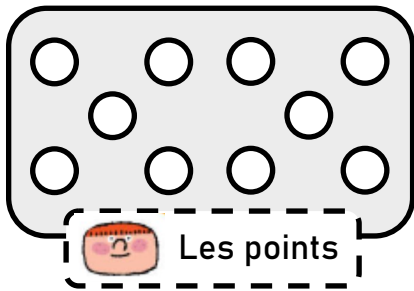

3 trois

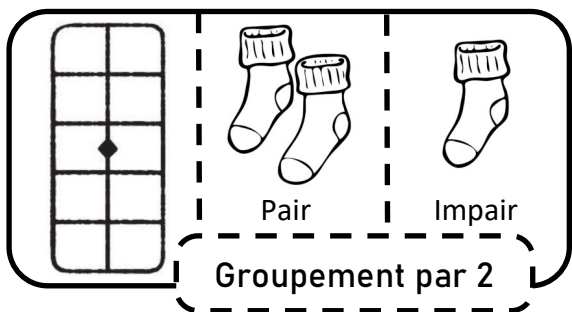
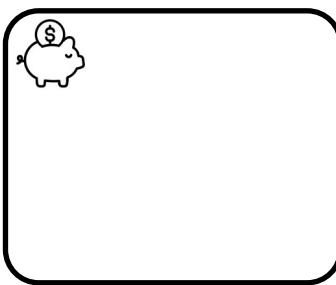
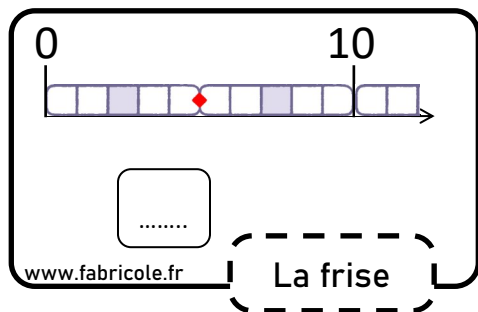
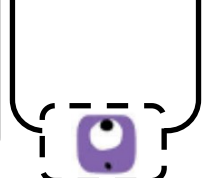
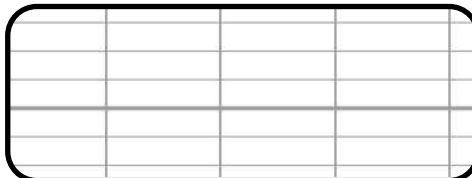

C'est notre quatrième jour de classe

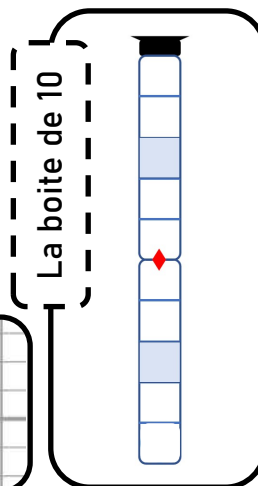
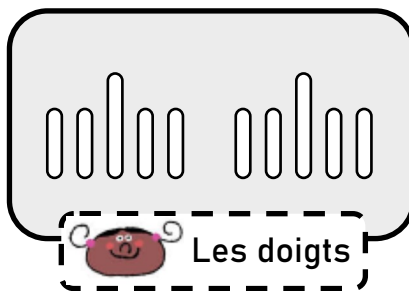
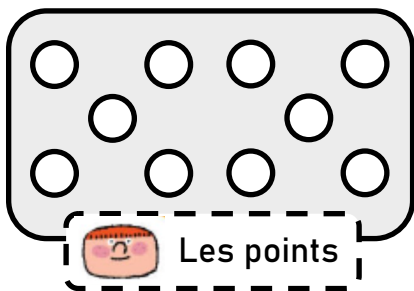

4 quatre

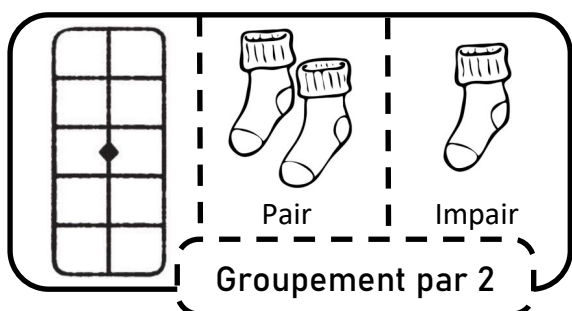
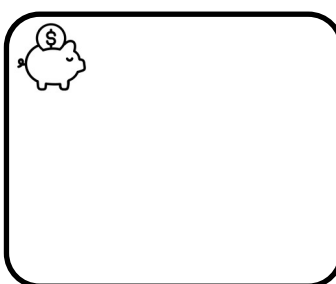
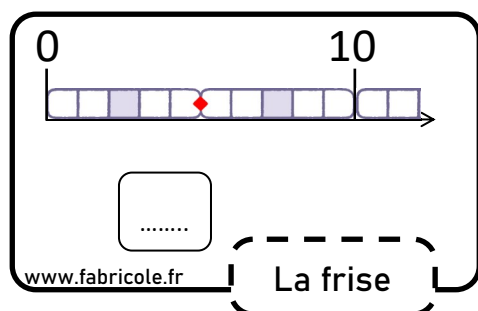
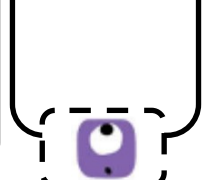
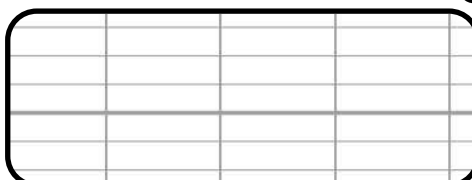

C'est notre cinquième jour de classe

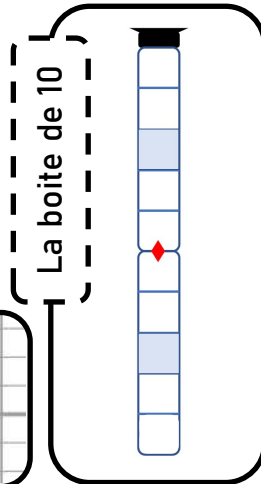
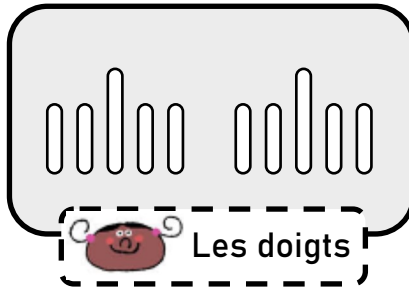
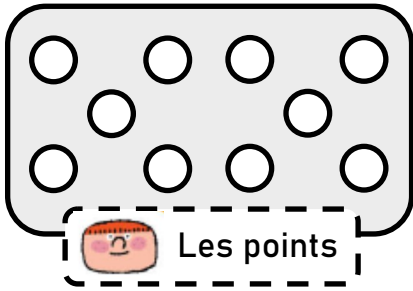

5 cinq

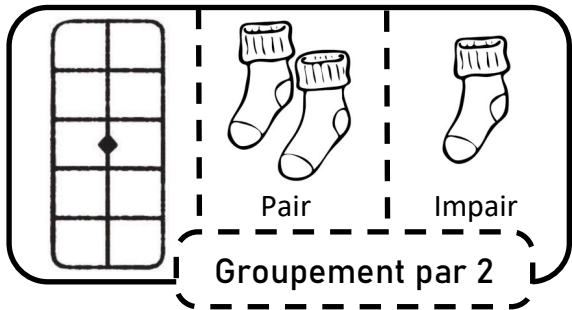
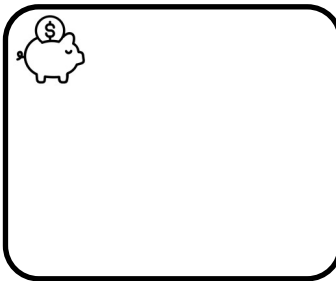
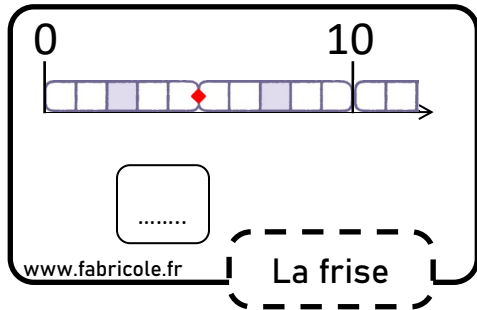
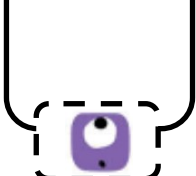
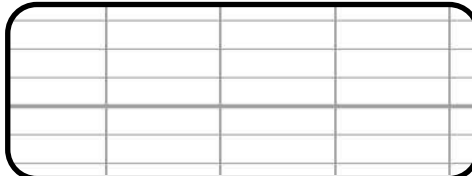

C'est notre sixième jour de classe

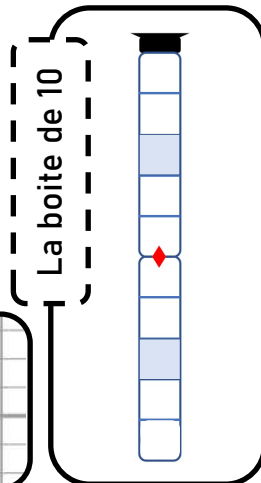
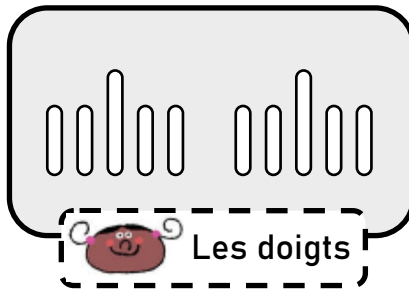
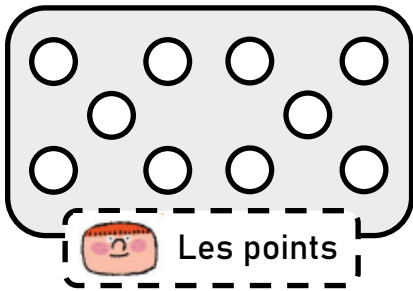

6 six

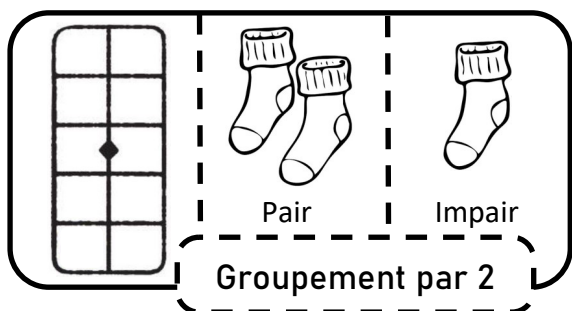
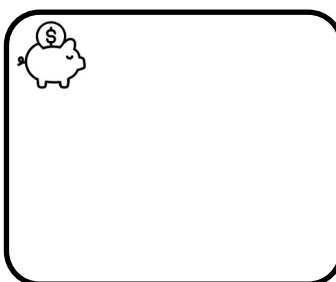
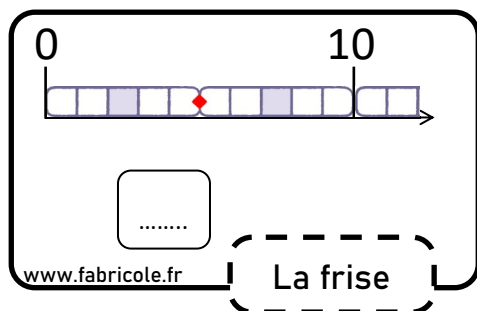
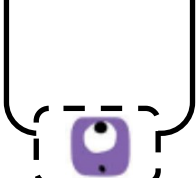
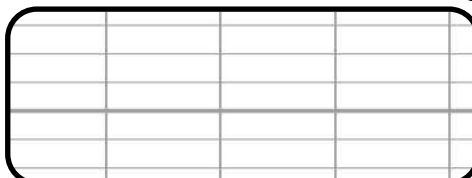

C'est notre septième jour de classe

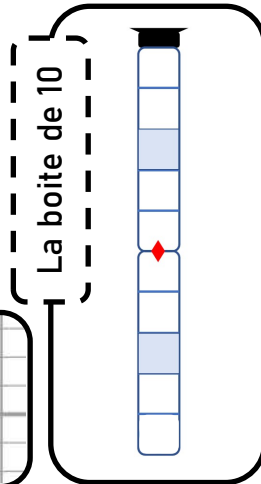
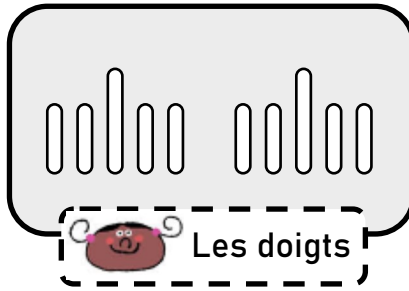
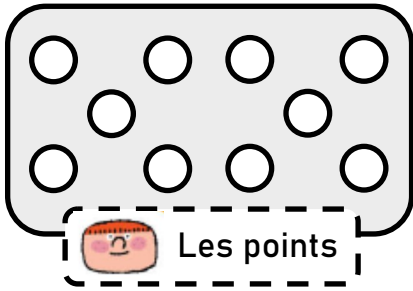

7 sept

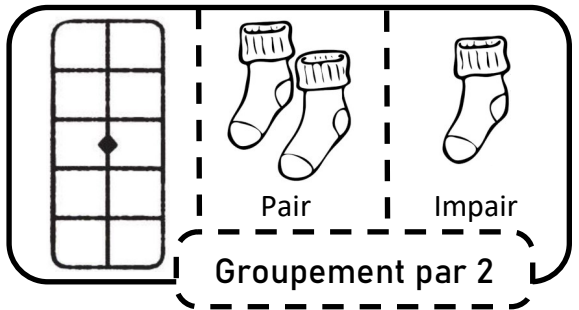
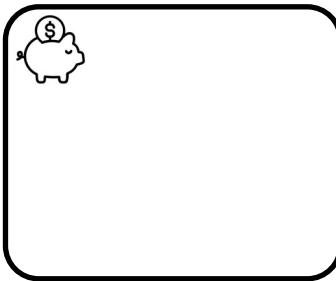
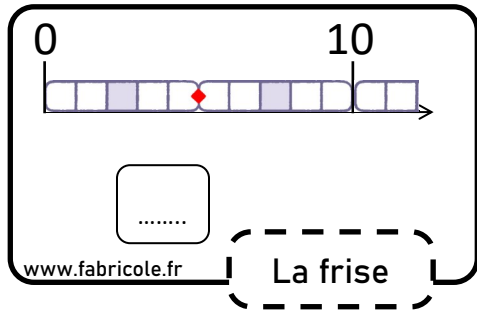
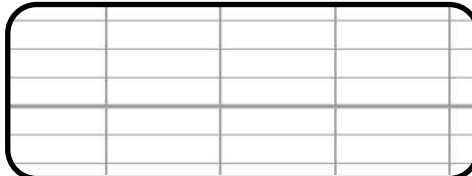

C'est notre huitième jour de classe

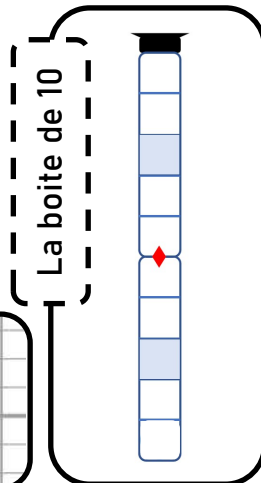
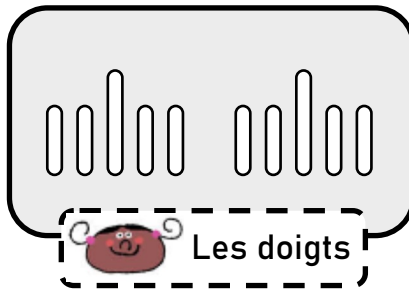
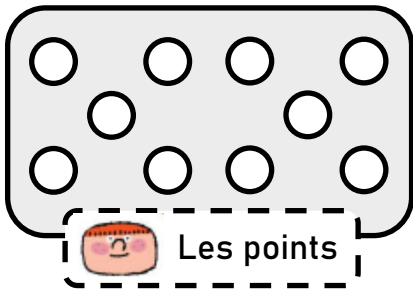

8 huit

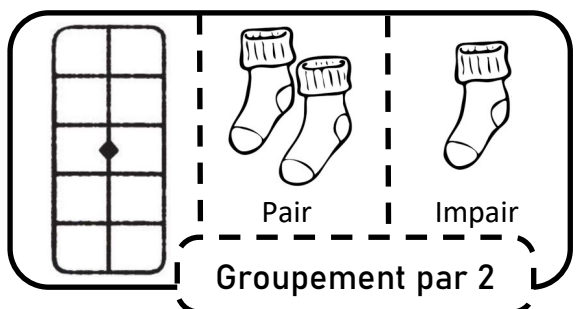
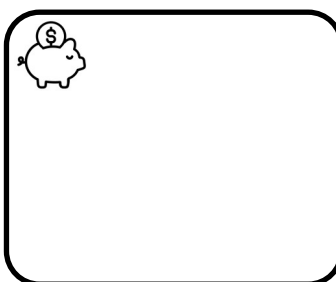
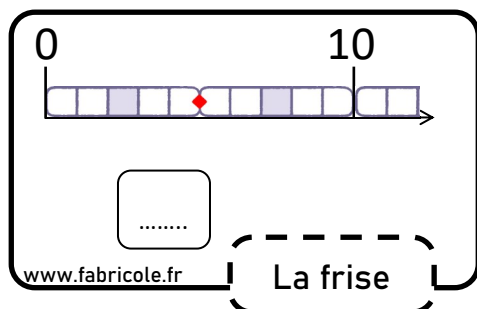
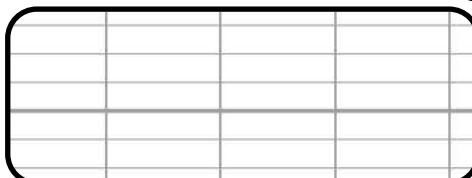

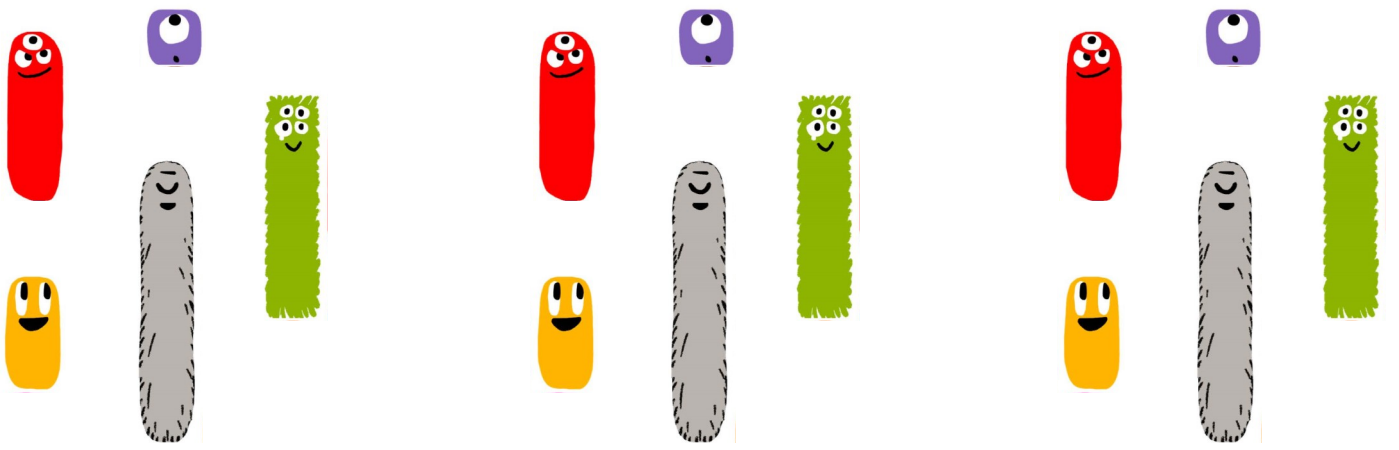
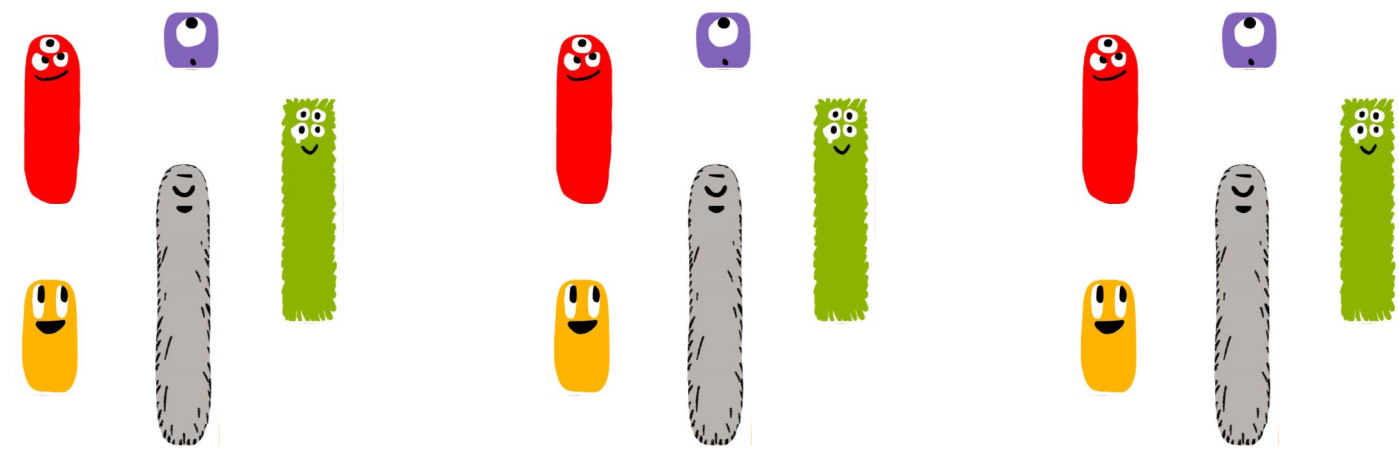
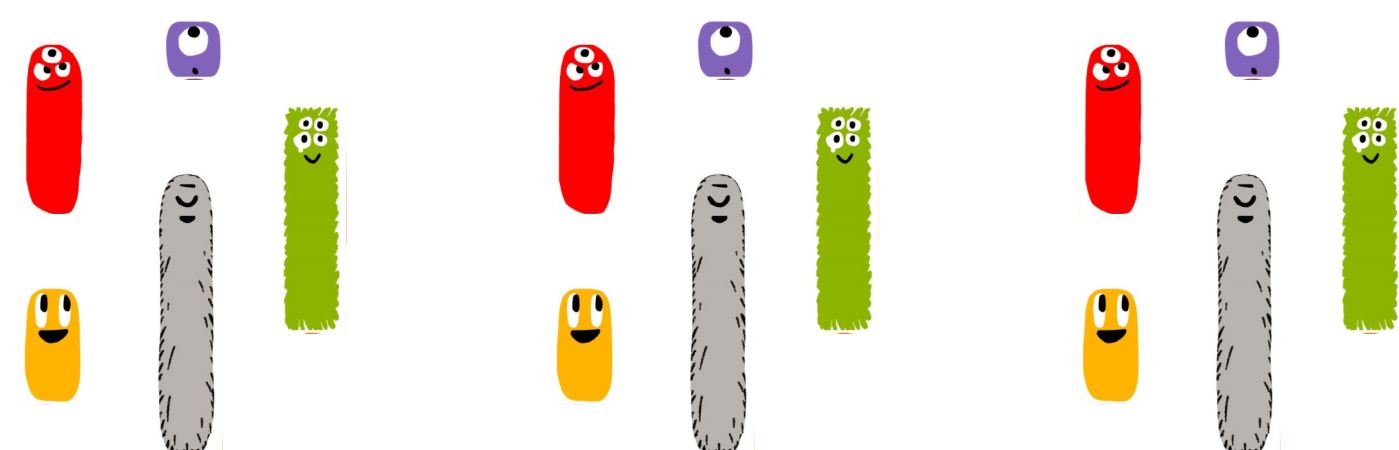
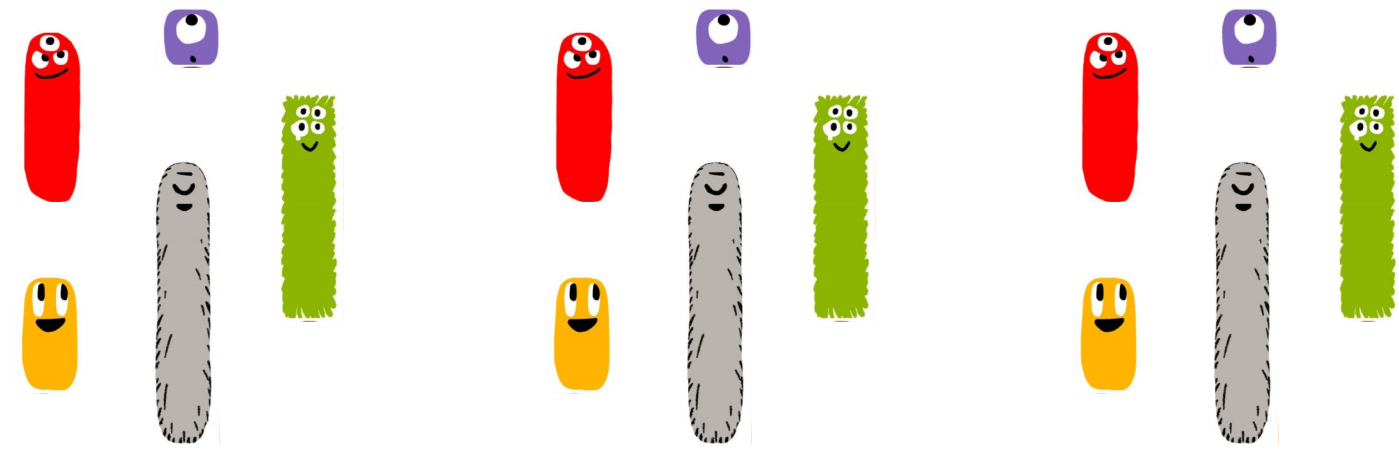

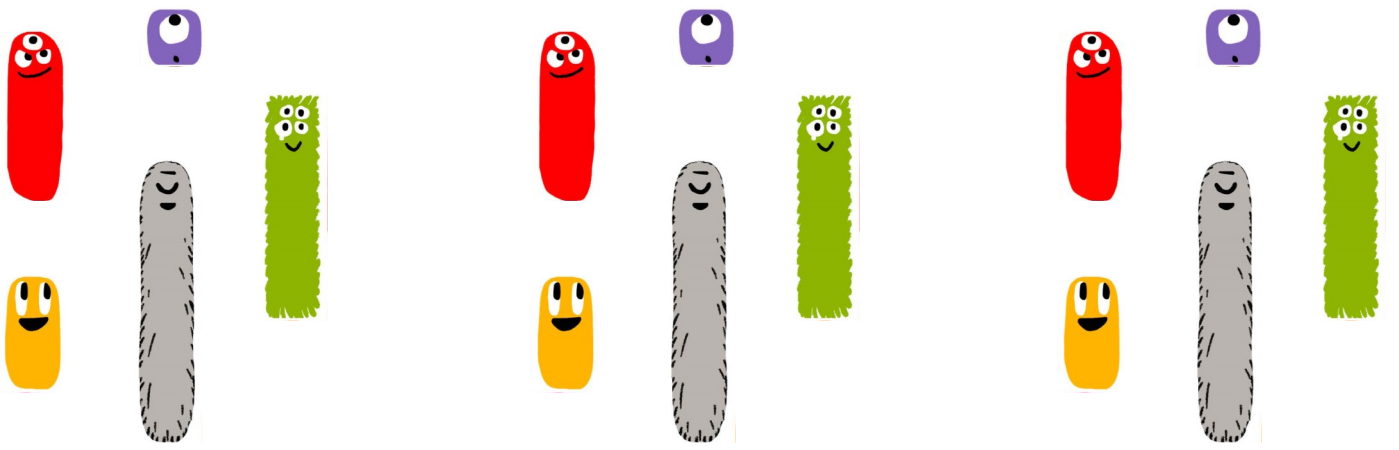
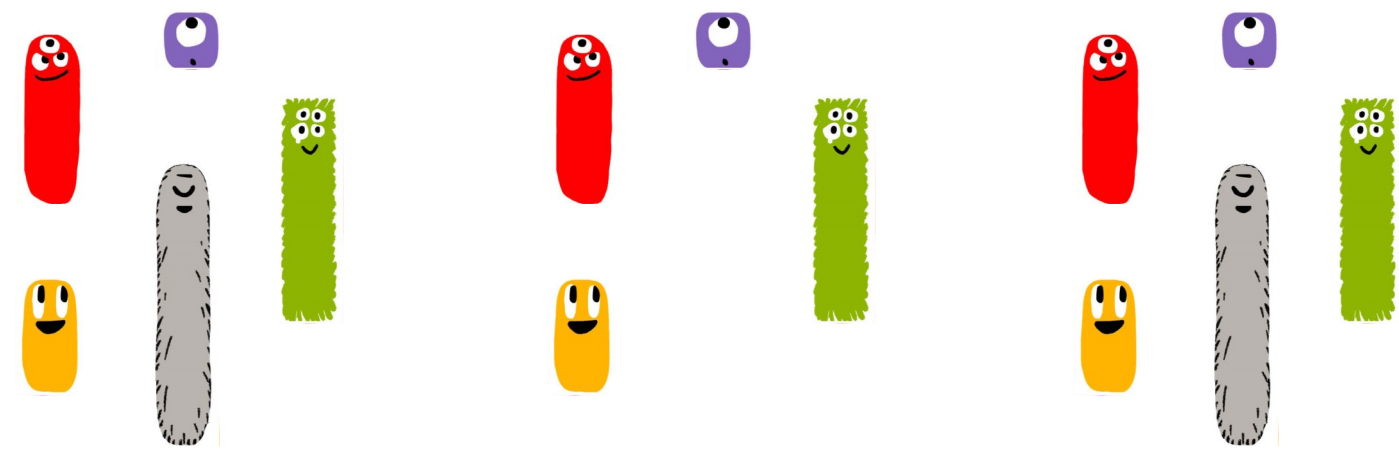
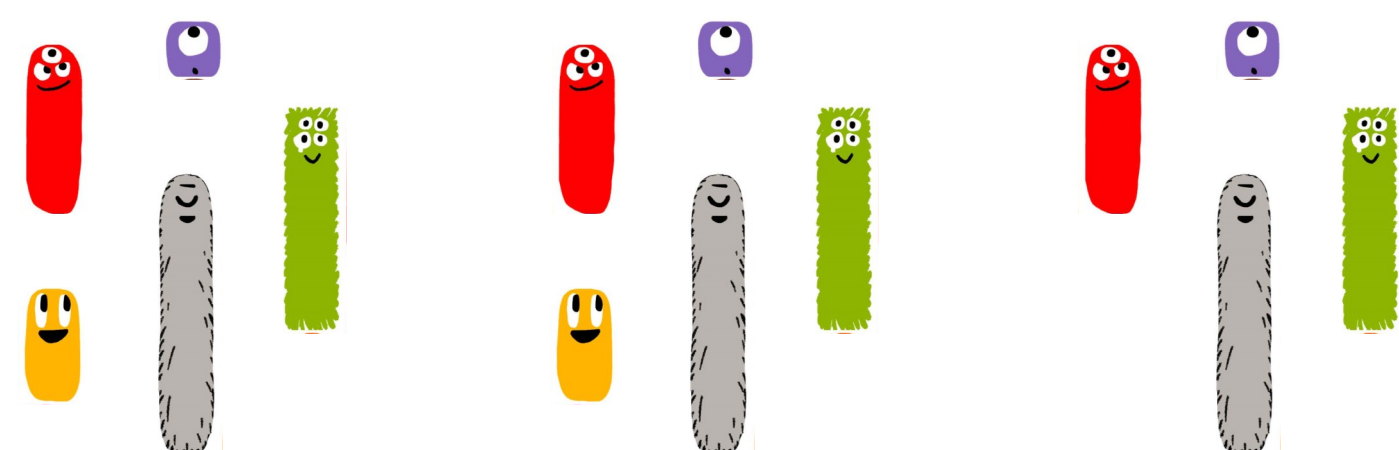
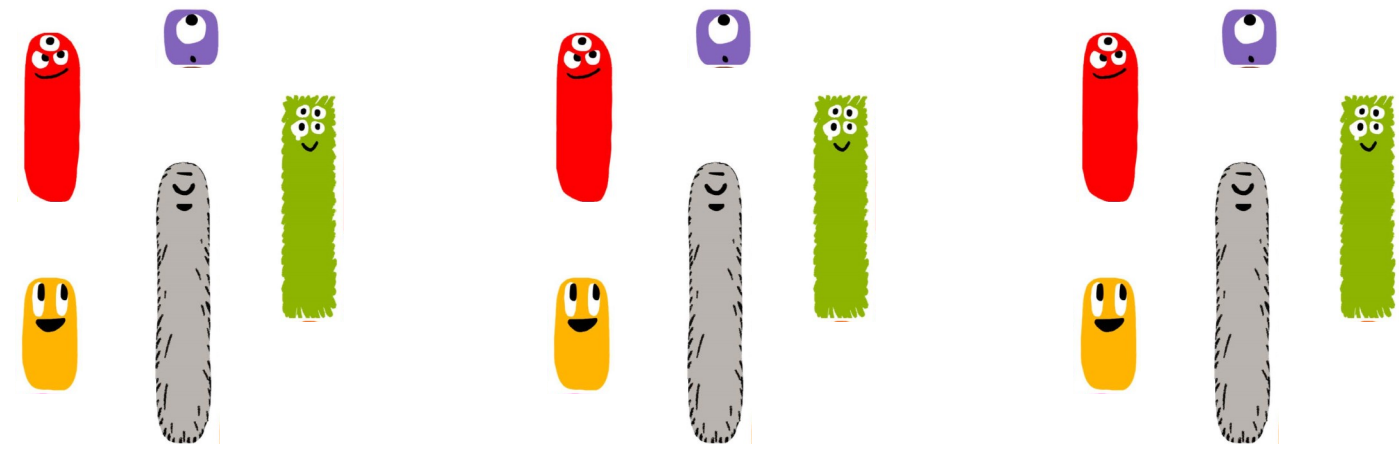

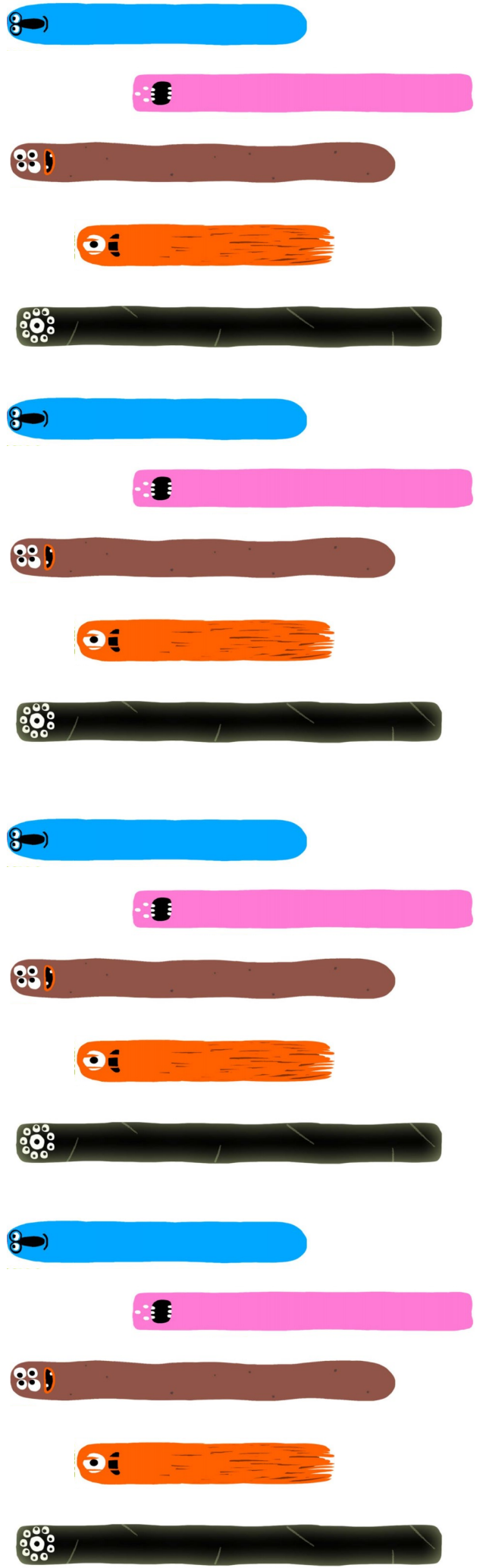
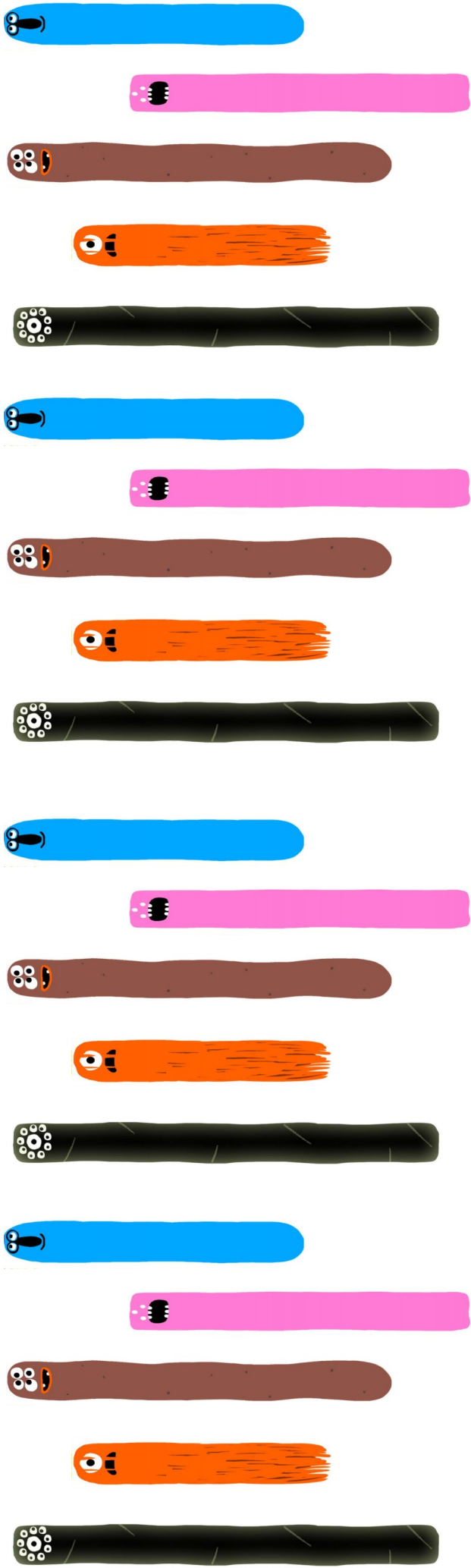

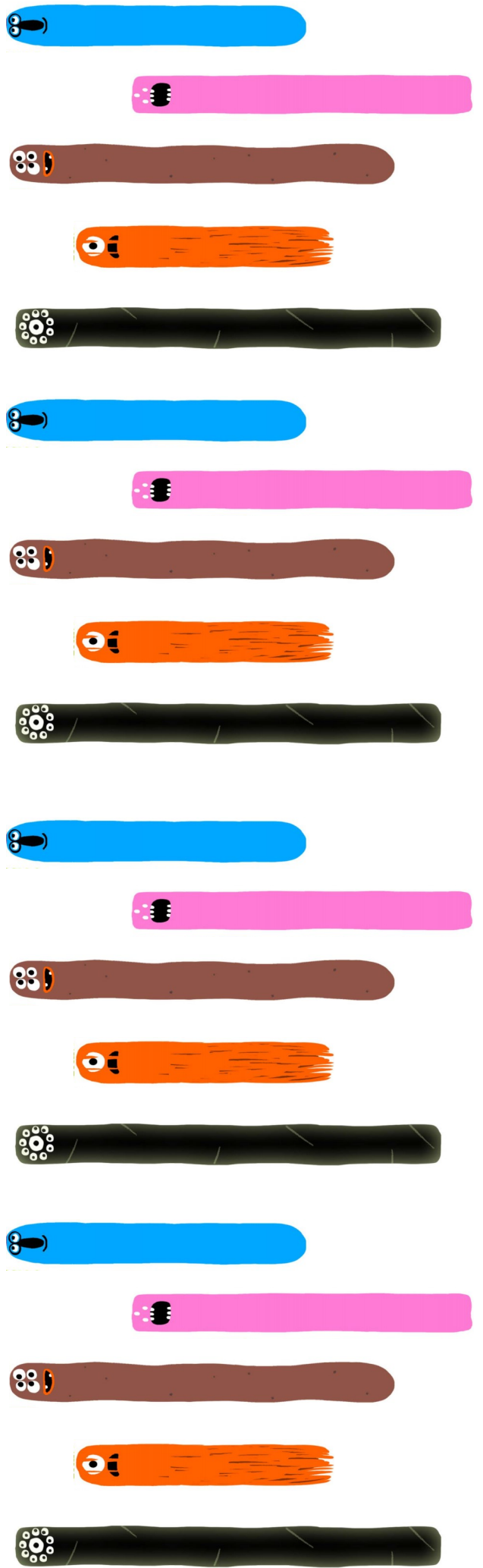
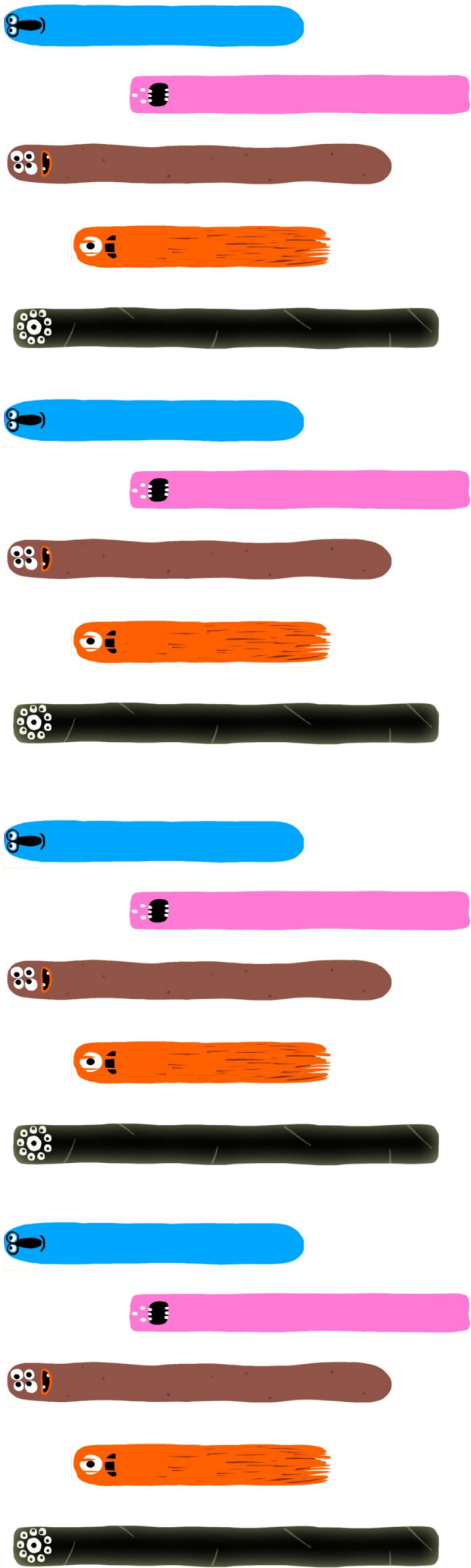

C'est notre neuvième jour de classe

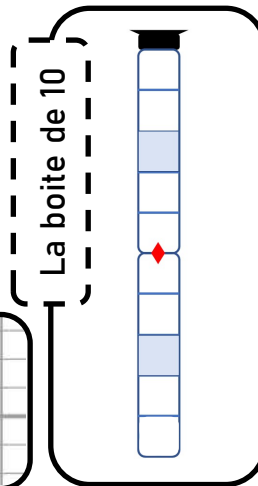
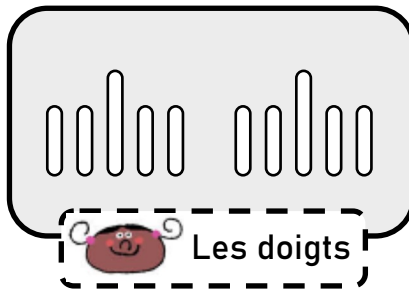
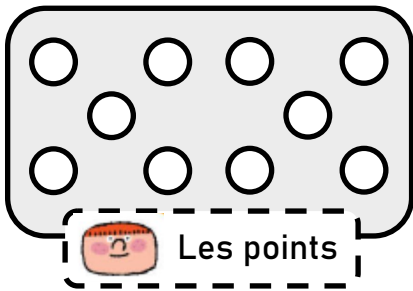

9 neuf

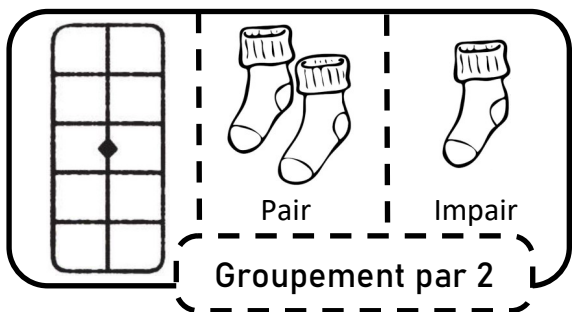
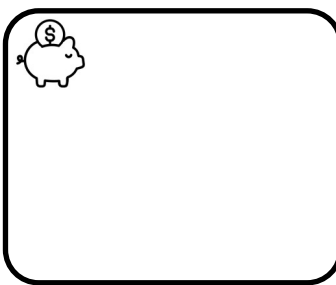
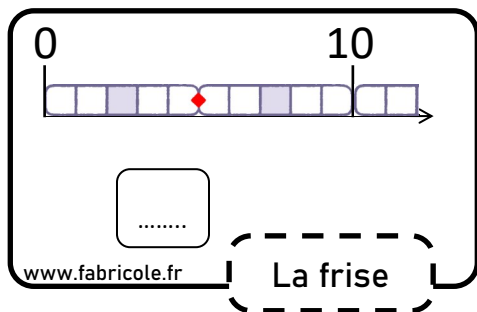
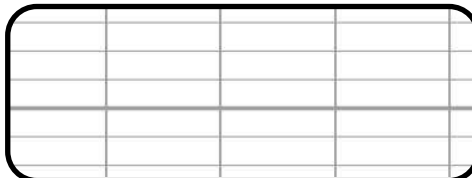

C'est notre dixième jour de classe

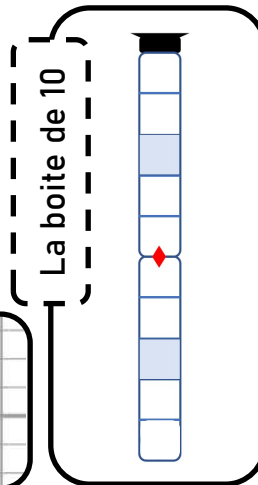
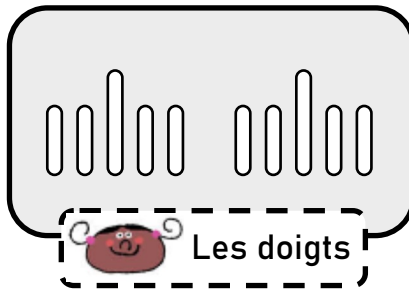
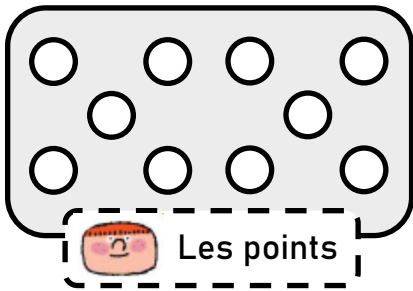

10 dix

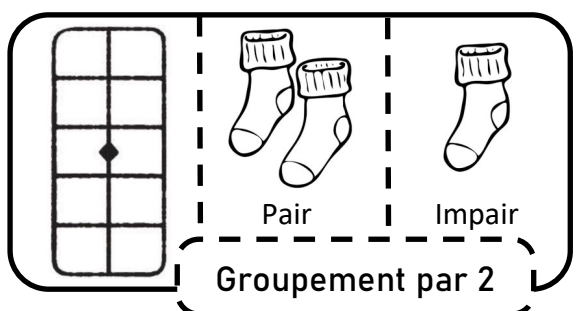
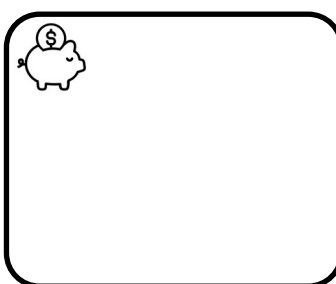
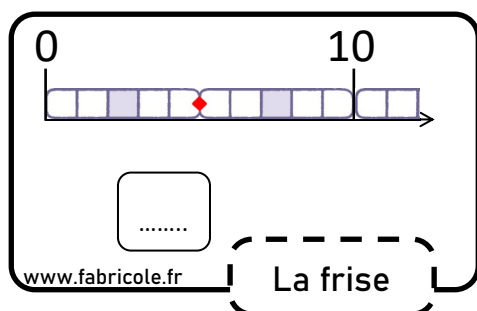
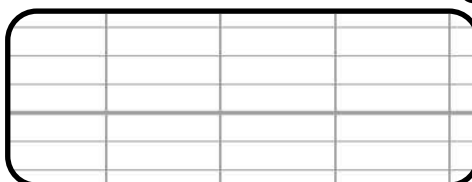

C'est notre onzième jour de classe

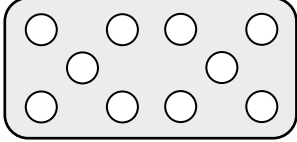
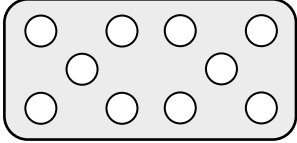

Les points

11 onze

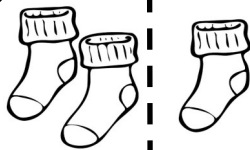
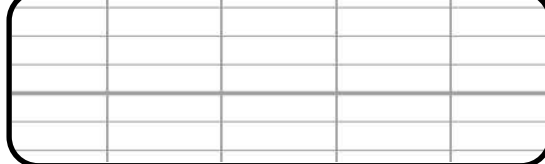

Pair ou impair

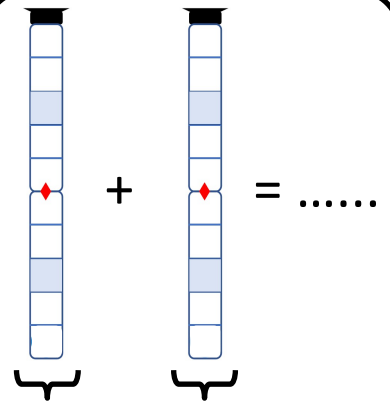

..... + = 11

La boîte de 10

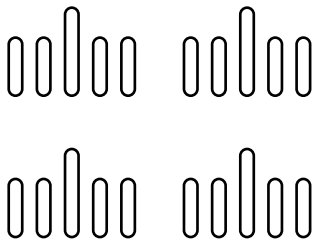

Les doigts



La frise



www.fabricole.fr

C'est notre douzième jour de classe

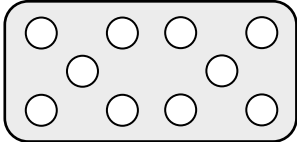
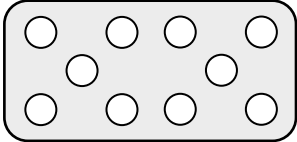

Les points

12 douze

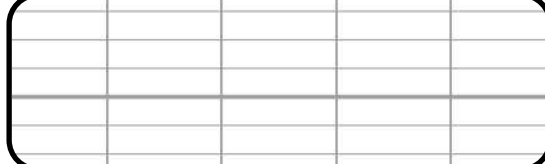

Pair ou impair

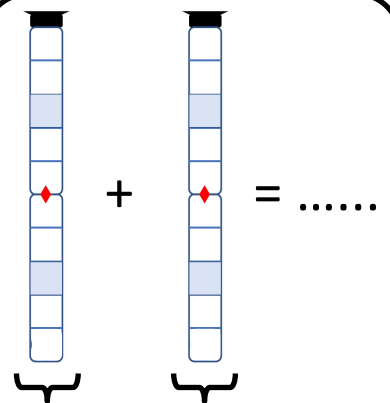

..... + = 12

La boîte de 10

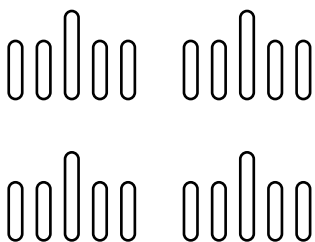

Les doigts

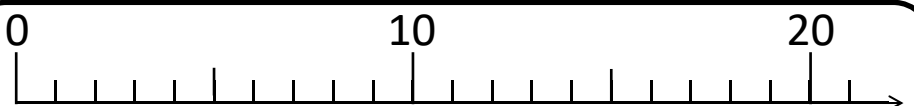

La frise



www.fabricole.fr

C'est notre treizième jour de classe

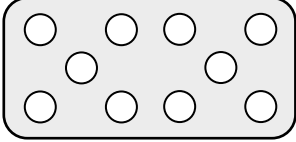
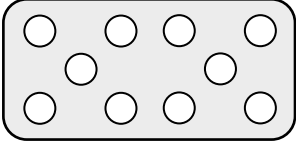

Les points

13 treize

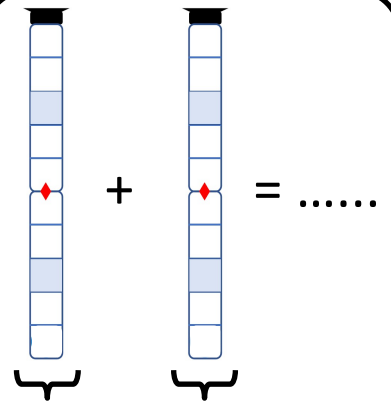

..... + = 13

La boîte de 10

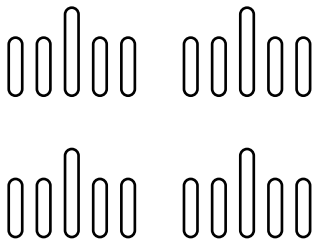

Les doigts

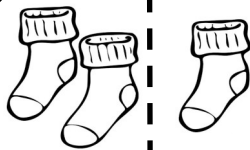

Pair ou impair

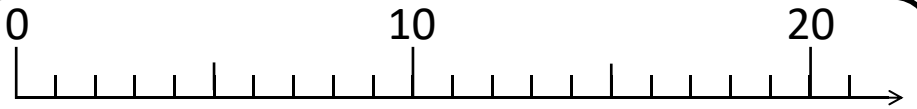

La frise

www.fabricole.fr

C'est notre quatorzième jour de classe

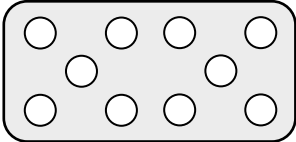
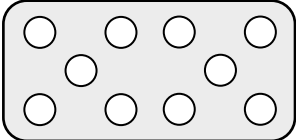

Les points

14 quatorze

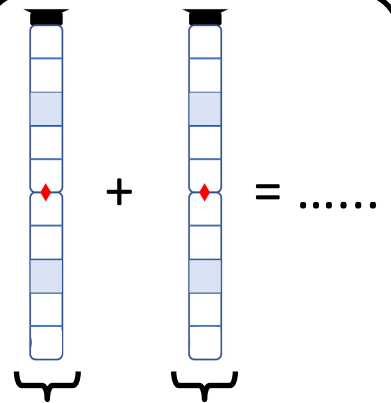

..... + = 14

La boîte de 10

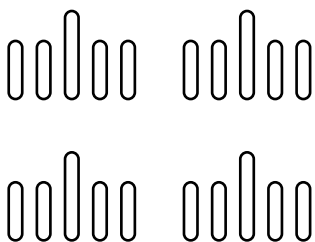

Les doigts



Pair ou impair

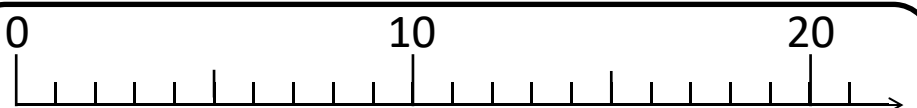

La frise

www.fabricole.fr

C'est notre quinzième jour de classe

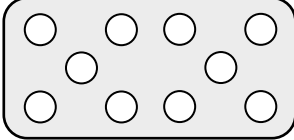
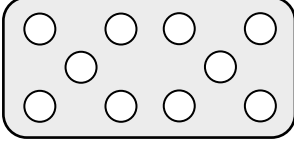

Les points

15 quinze



Pair ou impair

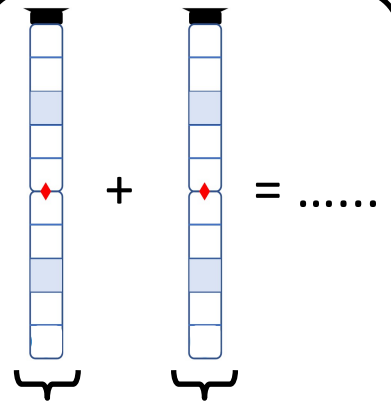

+ =

..... + = 15

La boîte de 10

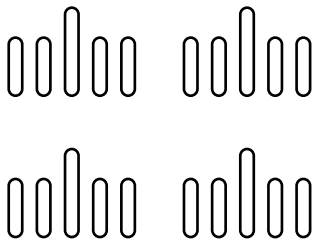

Les doigts



La frise



www.fabricole.fr

C'est notre seizième jour de classe

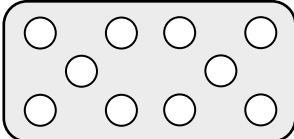
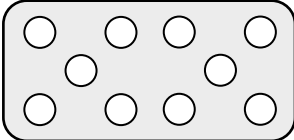

Les points

16 seize

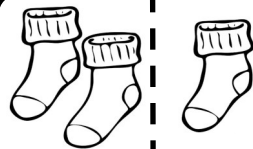

Pair ou impair

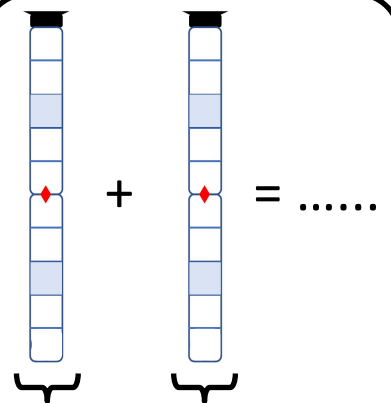

+ =

..... + = 16

La boîte de 10

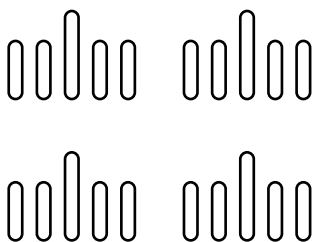

Les doigts

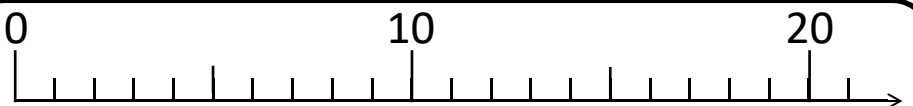

La frise



www.fabricole.fr

C'est notre dix-septième jour de classe

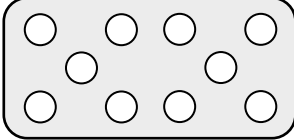
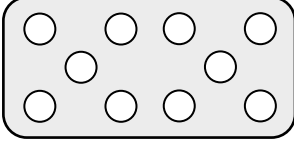

Les points

17 dix-sept

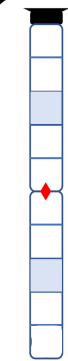

+

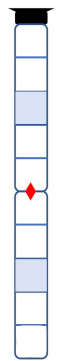

=



..... + = 17

La boîte de 10

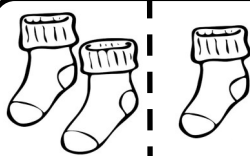

Pair ou impair

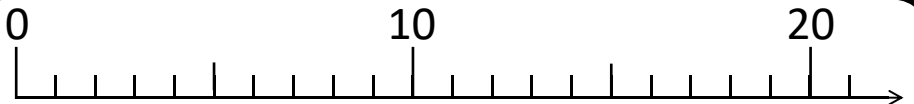

La frise

www.fabricole.fr

C'est notre dix-huitième jour de classe

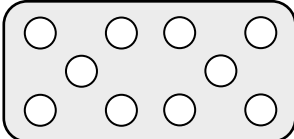
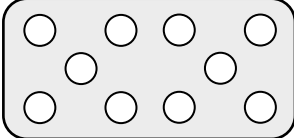

Les points

18 dix-huit

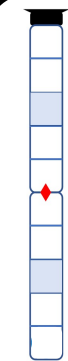

+

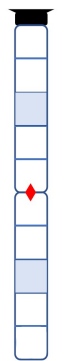

=



..... + = 18

La boîte de 10

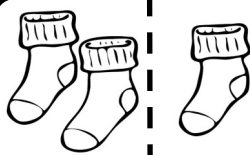

Pair ou impair



La frise

www.fabricole.fr

C'est notre dix-neuvième jour de classe

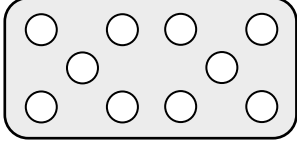
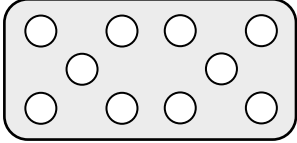

Les points

19 dix-neuf

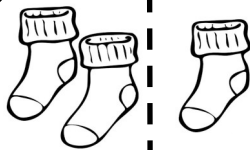
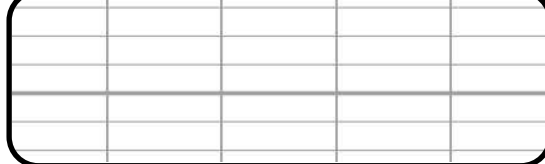

Pair ou impair

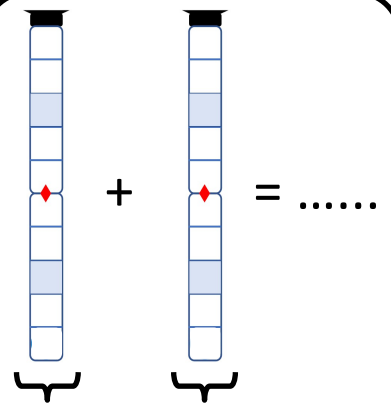

$$+ = \dots$$

$$\dots + \dots = 19$$

La boîte de 10

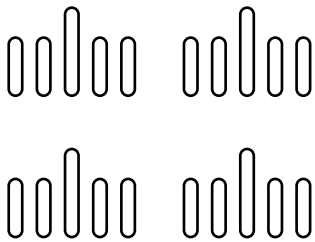

Les doigts



La frise



www.fabricole.fr

C'est notre vingtième jour de classe

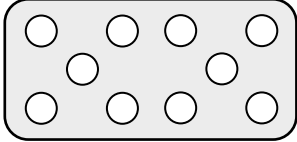
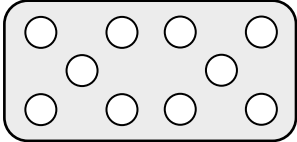

Les points

20 vingt

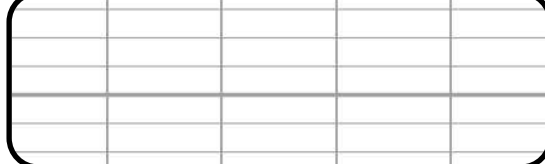

Pair ou impair

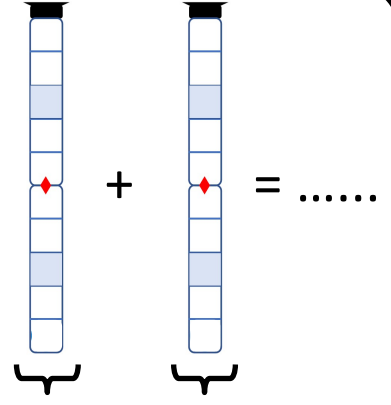

$$+ = \dots$$

$$\dots + \dots = 20$$

La boîte de 10

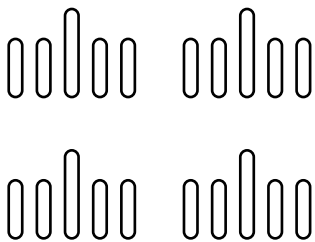

Les doigts

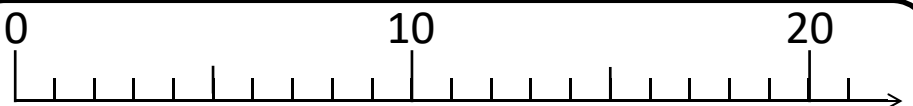

La frise



www.fabricole.fr

C'est notre vingt-et-unième jour de classe

$$\dots\dots + \dots\dots = 21$$

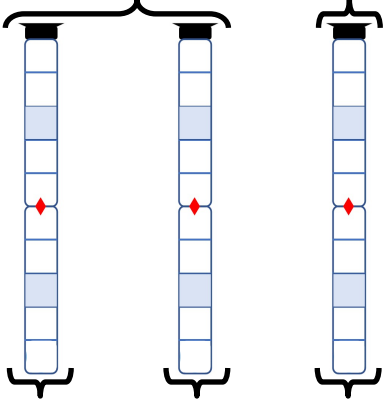

$$\dots\dots + \dots\dots + \dots\dots = 21$$

Les boîtes de 10 et unités

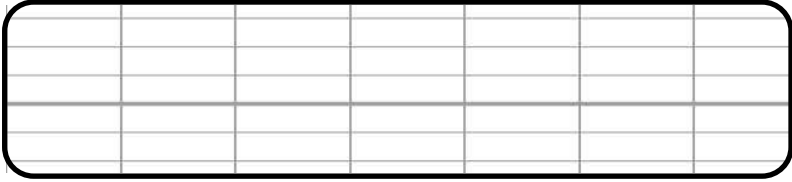

$$\dots\dots < 21 < \dots\dots$$

Les encadrements

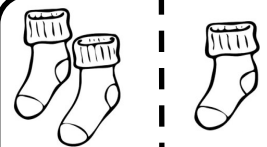

Pair ou impair

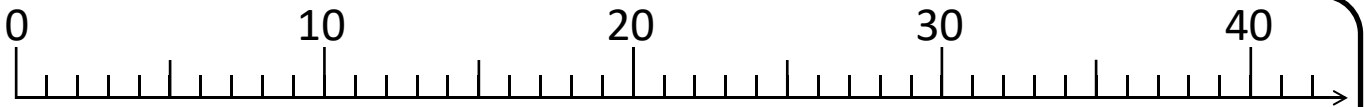

La frise

.....

www.fabricole.fr

C'est notre vingt-deuxième jour de classe

$$\dots\dots + \dots\dots = 22$$

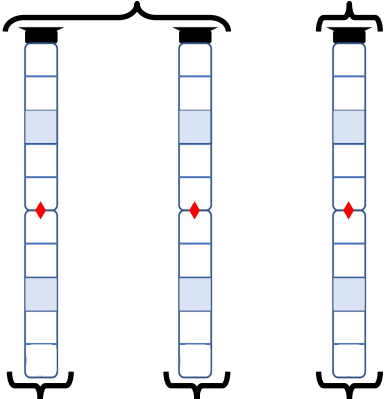

$$\dots\dots + \dots\dots + \dots\dots = 22$$

Les boîtes de 10 et unités

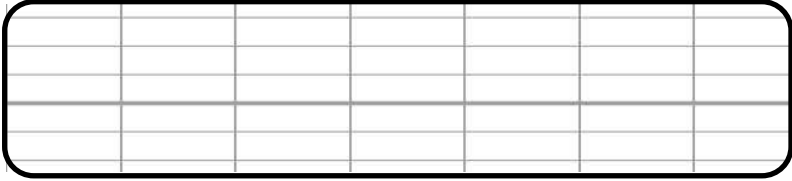

$$\dots\dots < 22 < \dots\dots$$

Les encadrements

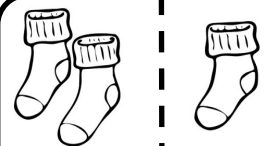

Pair ou impair

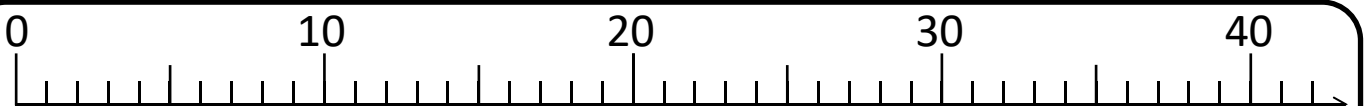

La frise

.....

www.fabricole.fr

C'est notre vingt-troisième jour de classe

$$\dots\dots\dots + \dots\dots\dots = 23$$

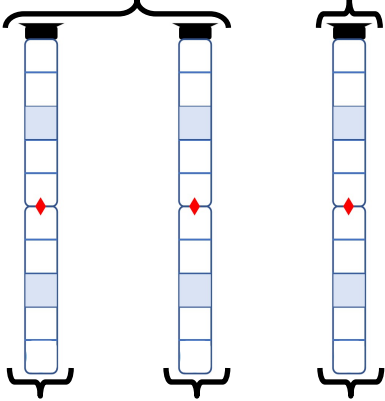

$$\dots\dots\dots + \dots\dots\dots + \dots\dots\dots = 23$$

Les boîtes de 10 et unités

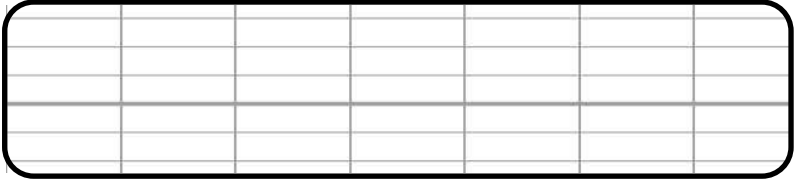

$$\dots\dots\dots < 23 < \dots\dots\dots$$

Les encadrements

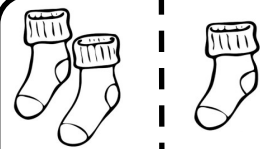

Pair ou impair



La frise

.....

www.fabricole.fr

C'est notre vingt-quatrième jour de classe

$$\dots\dots\dots + \dots\dots\dots = 24$$

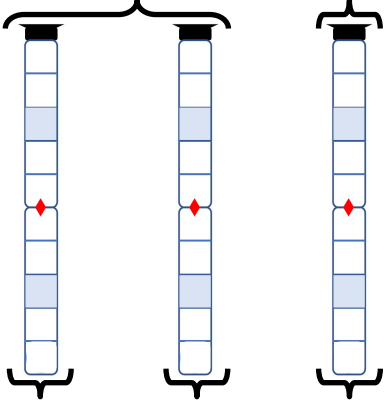

$$\dots\dots\dots + \dots\dots\dots + \dots\dots\dots = 24$$

Les boîtes de 10 et unités

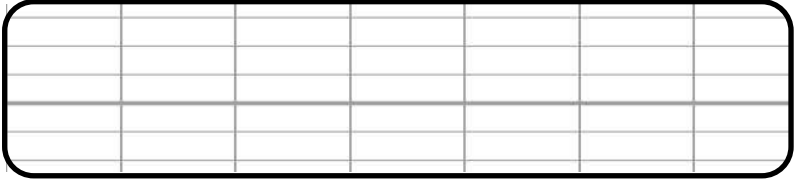

$$\dots\dots\dots < 24 < \dots\dots\dots$$

Les encadrements

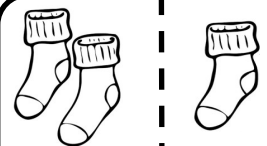

Pair ou impair

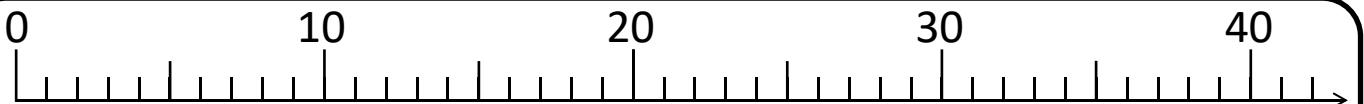

La frise

.....

www.fabricole.fr

C'est notre vingt-cinquième jour de classe

$$\dots\dots + \dots\dots = 25$$

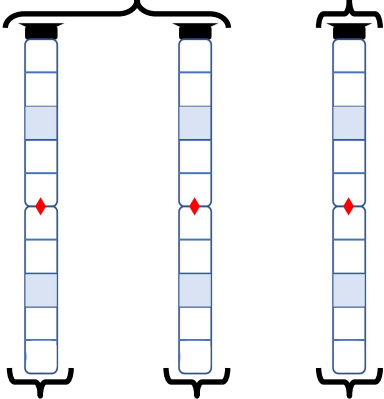

$$\dots\dots + \dots\dots + \dots\dots = 25$$

Les boîtes de 10 et unités

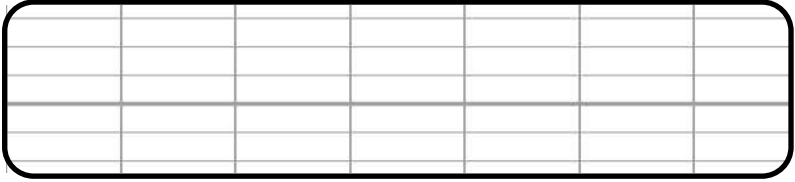

$$\dots\dots < 25 < \dots\dots$$

Les encadrements

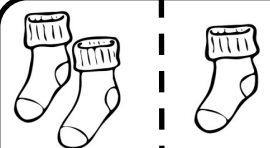

Pair ou impair

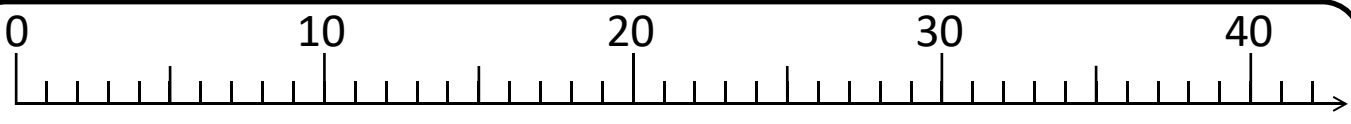

La frise

.....

C'est notre vingt-sixième jour de classe

$$\dots\dots + \dots\dots = 26$$

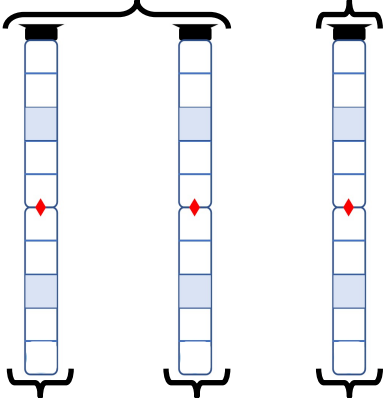

$$\dots\dots + \dots\dots + \dots\dots = 26$$

Les boîtes de 10 et unités

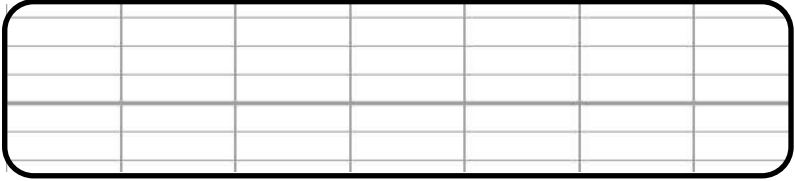

$$\dots\dots < 26 < \dots\dots$$

Les encadrements

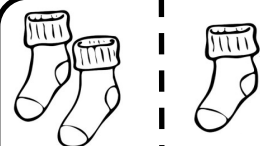

Pair ou impair

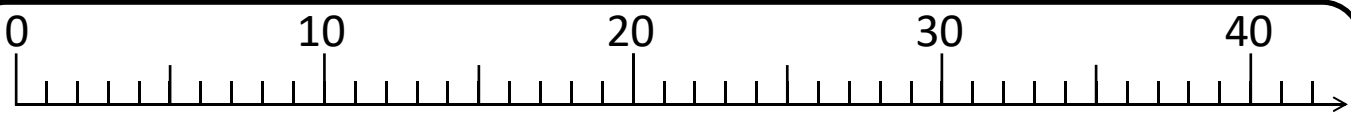

La frise

.....

C'est notre vingt-septième jour de classe

..... + = 27

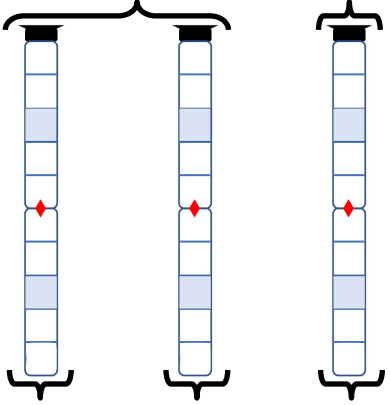

..... + + = 27

Les boîtes de 10 et unités



..... < 27 <

Les encadrements

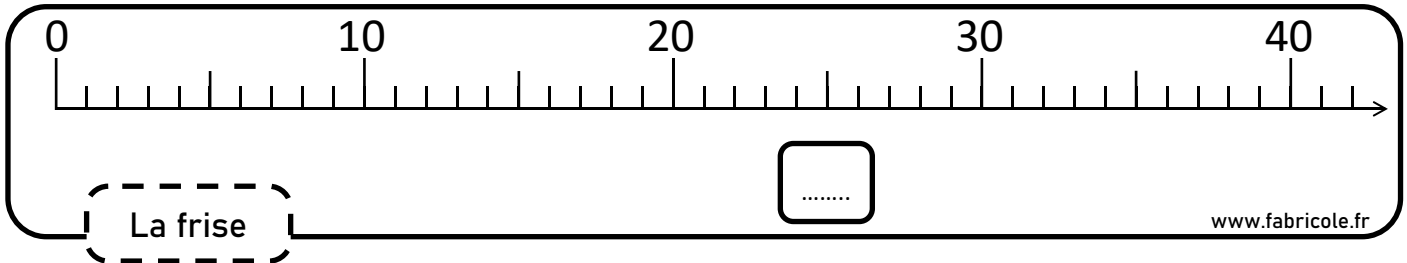
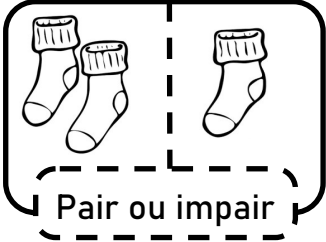

C'est notre vingt-huitième jour de classe

..... + = 28

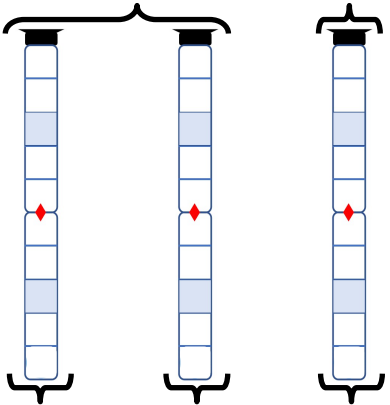

..... + + = 28

Les boîtes de 10 et unités



..... < 28 <

Les encadrements

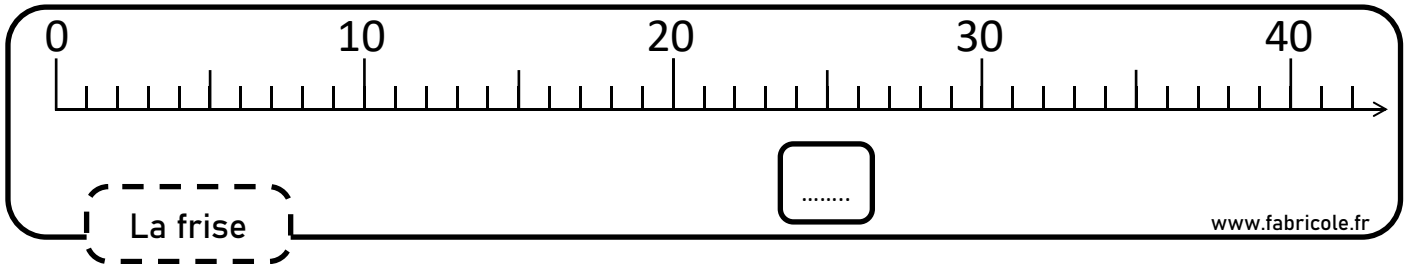
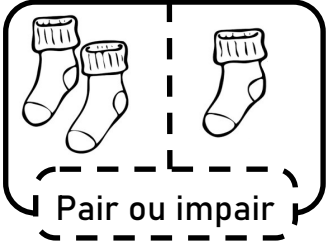

C'est notre vingt-neuvième jour de classe

$$\dots\dots + \dots\dots = 29$$

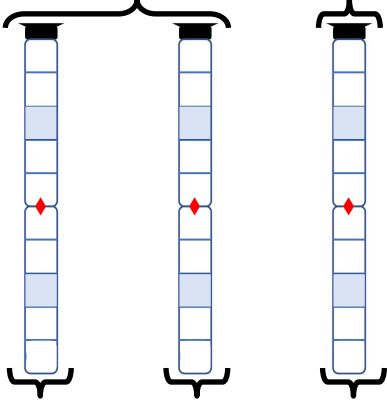

$$\dots\dots + \dots\dots + \dots\dots = 29$$

Les boîtes de 10 et unités

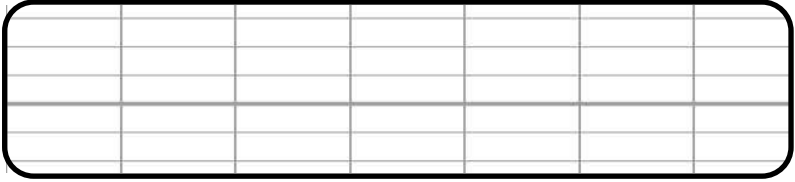

$$\dots\dots < 29 < \dots\dots$$

Les encadrements

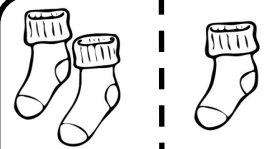

Pair ou impair



La frise

.....

www.fabricole.fr

C'est notre trentième jour de classe

$$\dots\dots + \dots\dots = 30$$

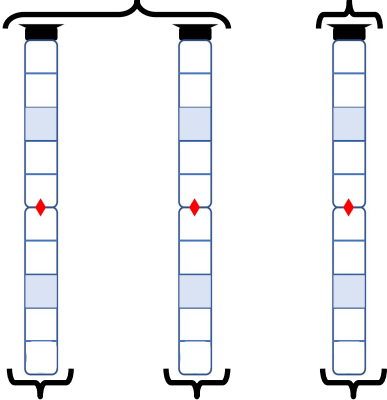

$$\dots\dots + \dots\dots + \dots\dots = 30$$

Les boîtes de 10 et unités

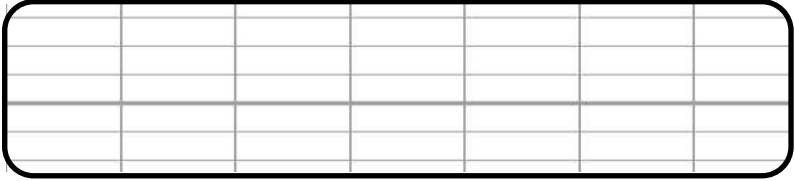

$$\dots\dots < 30 < \dots\dots$$

Les encadrements

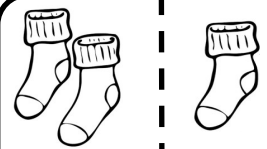

Pair ou impair

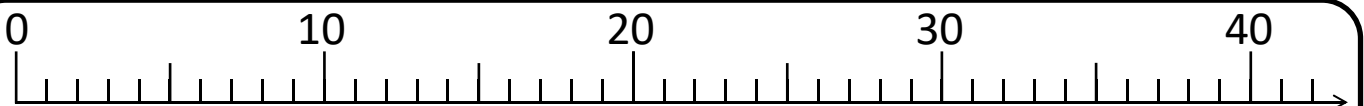

La frise

.....

www.fabricole.fr

C'est notre trente-et-unième jour de classe

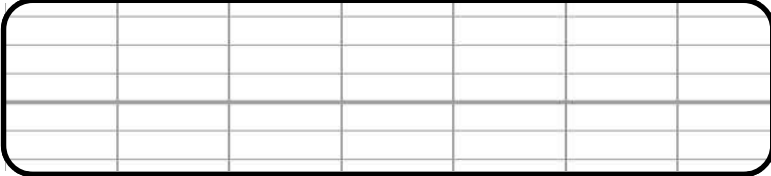

Dizaines: Unités:

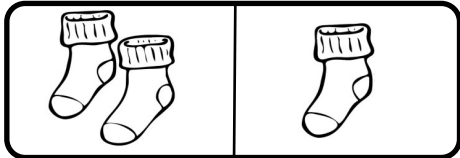

..... < 31 <

..... + = 31

..... + + + = 31

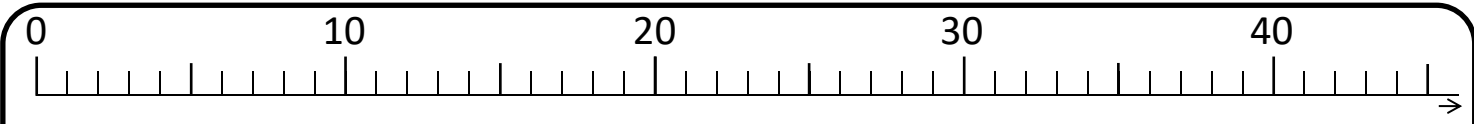

.....

La frise

C'est notre trente-deuxième jour de classe

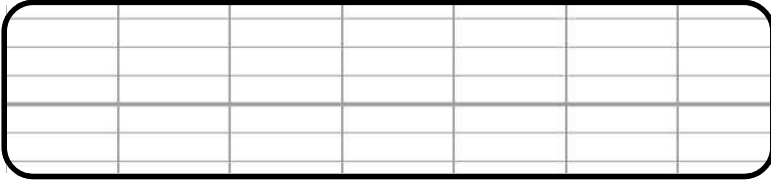

Dizaines: Unités:

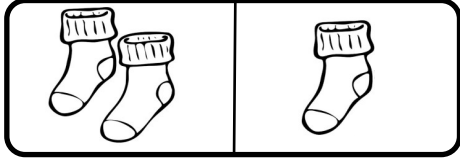

..... < 32 <

..... + = 32

..... + + + = 32

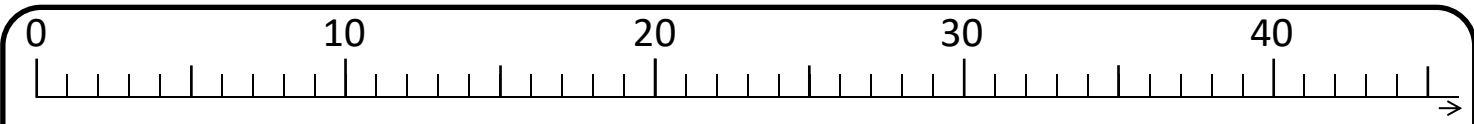

.....

La frise

C'est notre trente-troisième jour de classe

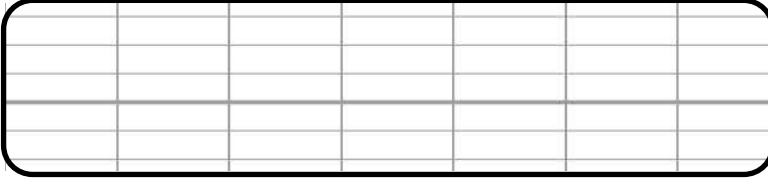

Dizaines: <input type="text"/>	Unités: <input type="text"/>
--------------------------------	------------------------------

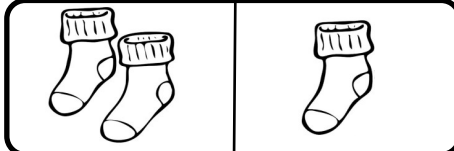

..... < 33 <

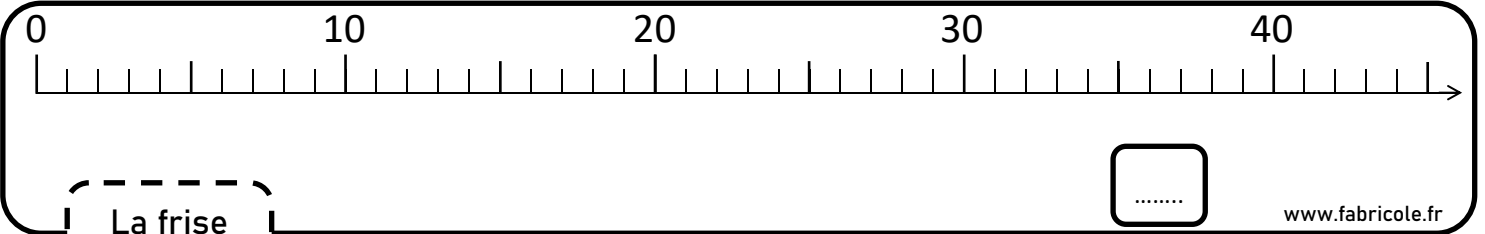
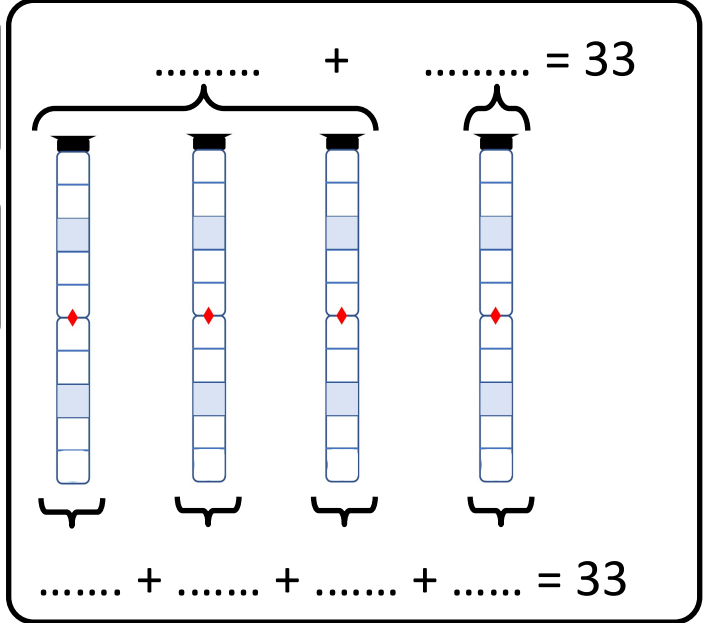

C'est notre trente-quatrième jour de classe

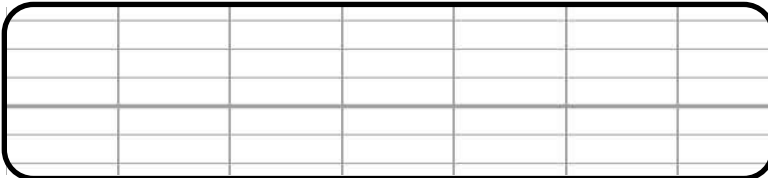

Dizaines: <input type="text"/>	Unités: <input type="text"/>
--------------------------------	------------------------------

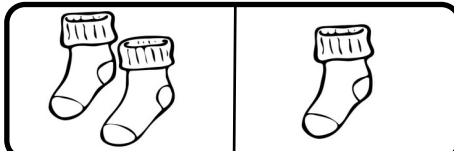

..... < 34 <

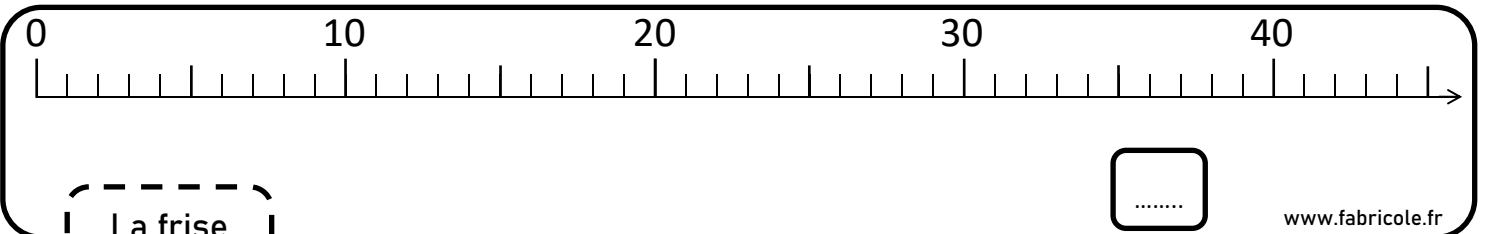
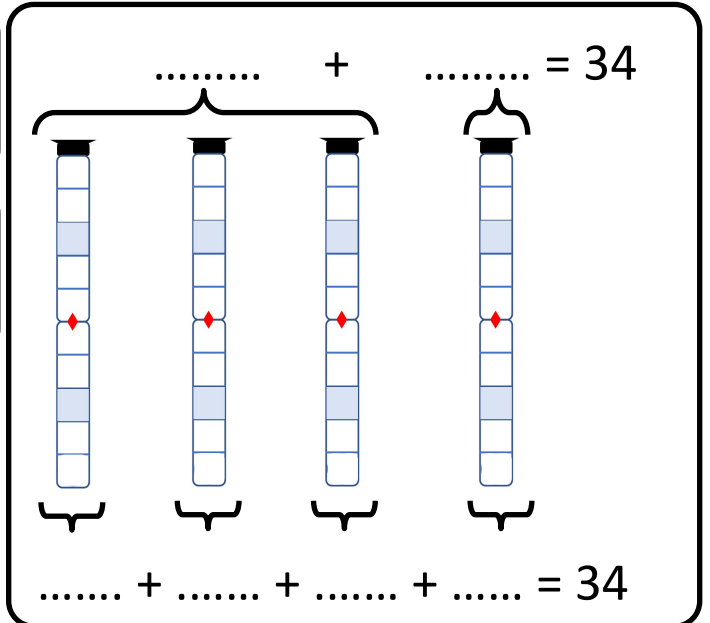

C'est notre trente-cinquième jour de classe

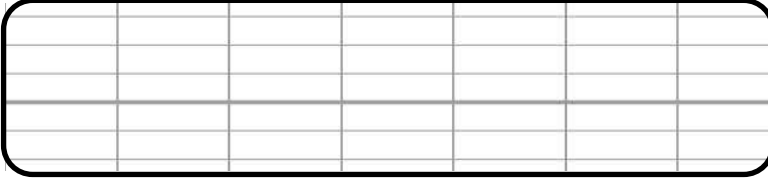

Dizaines: <input type="text"/>	Unités: <input type="text"/>
--------------------------------	------------------------------

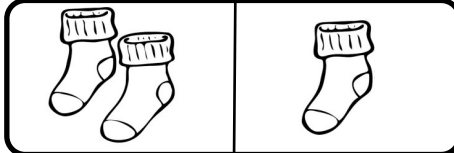

..... < 35 <

..... + = 35

..... + + + = 35

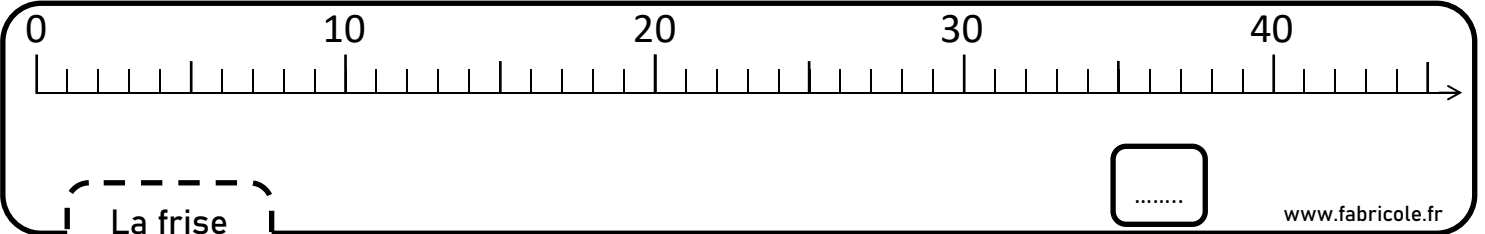

C'est notre trente-sixième jour de classe

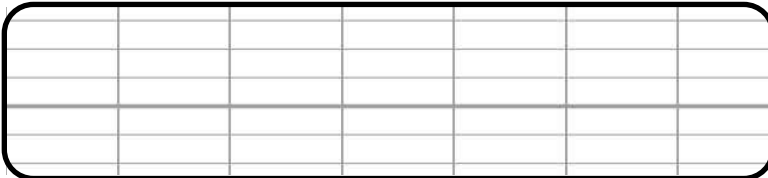

Dizaines: <input type="text"/>	Unités: <input type="text"/>
--------------------------------	------------------------------

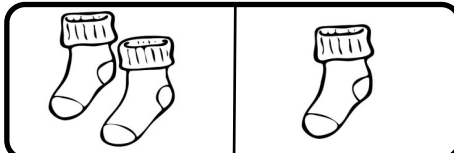

..... < 36 <

..... + = 36

..... + + + = 36

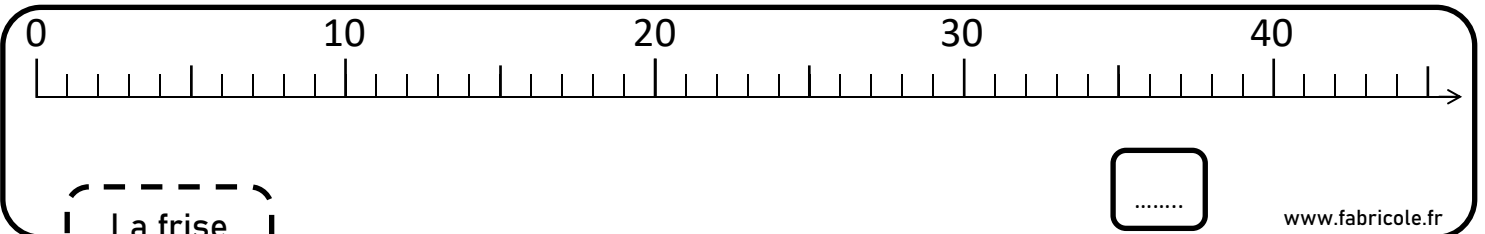

C'est notre trente-septième jour de classe

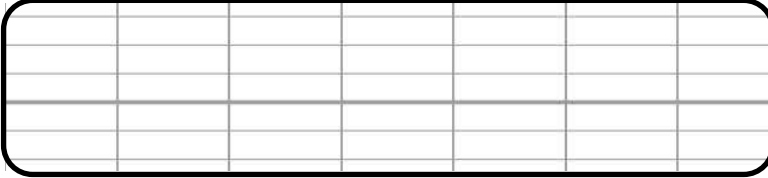

Dizaines: <input type="text"/>	Unités: <input type="text"/>
--------------------------------	------------------------------

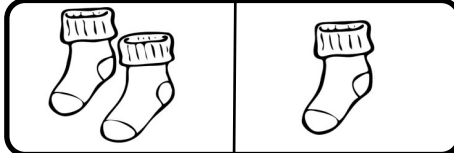

..... < 37 <

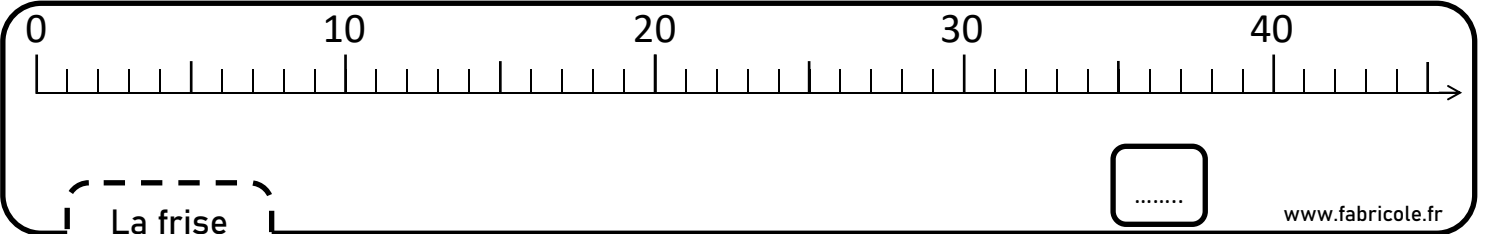
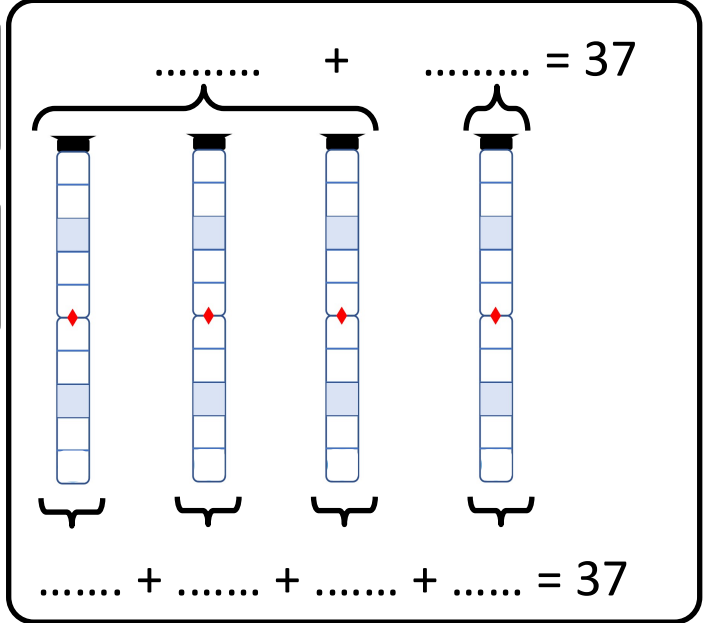

C'est notre trente-huitième jour de classe

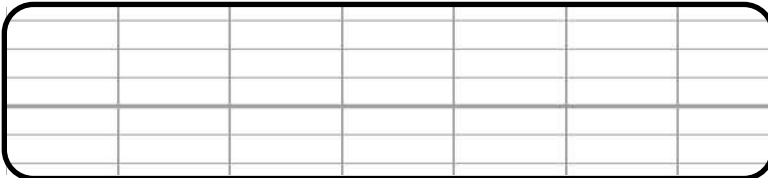

Dizaines: <input type="text"/>	Unités: <input type="text"/>
--------------------------------	------------------------------

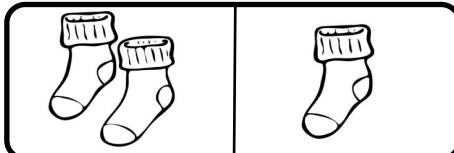

..... < 38 <

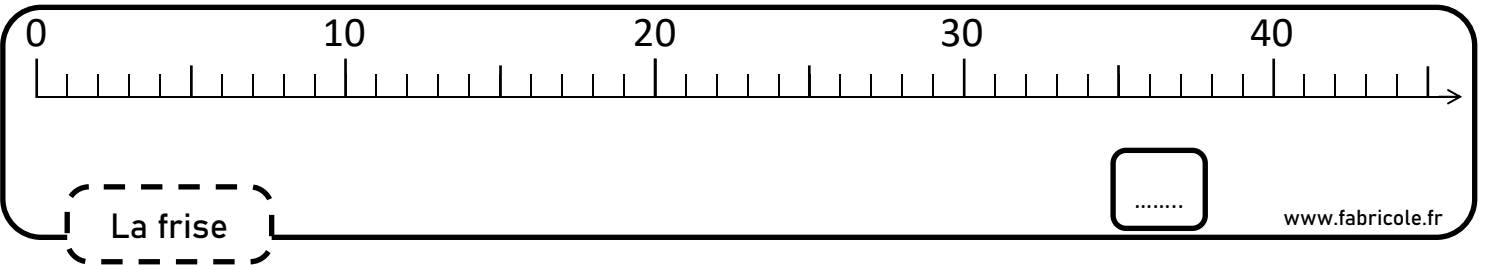
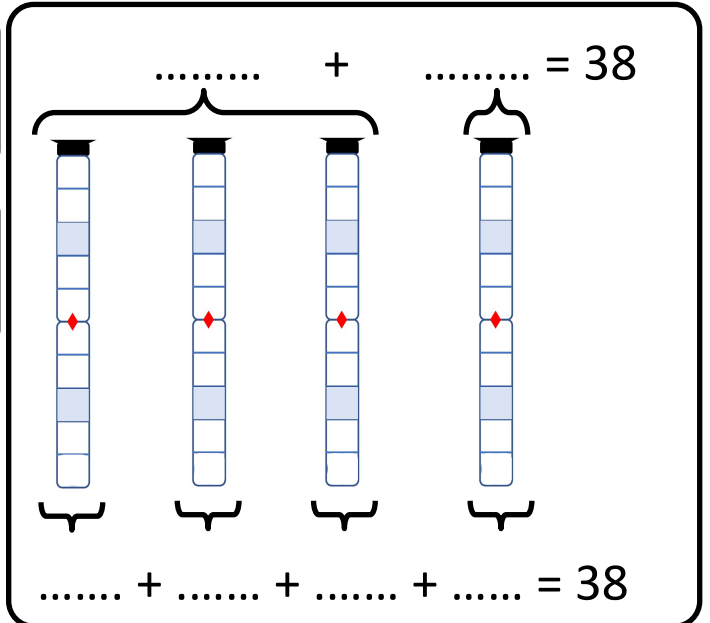

C'est notre trente-neuvième jour de classe

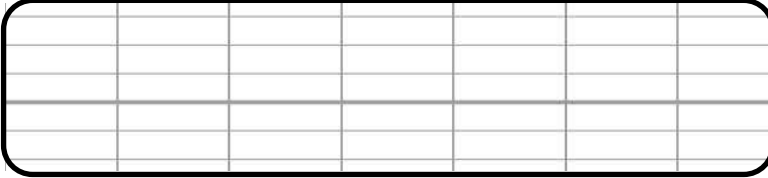

Dizaines: <input type="text"/>	Unités: <input type="text"/>
--------------------------------	------------------------------

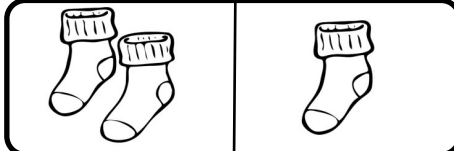

..... < 39 <

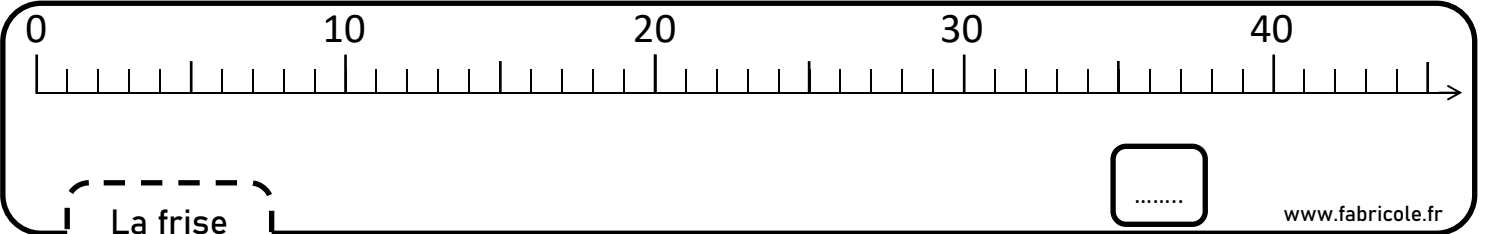
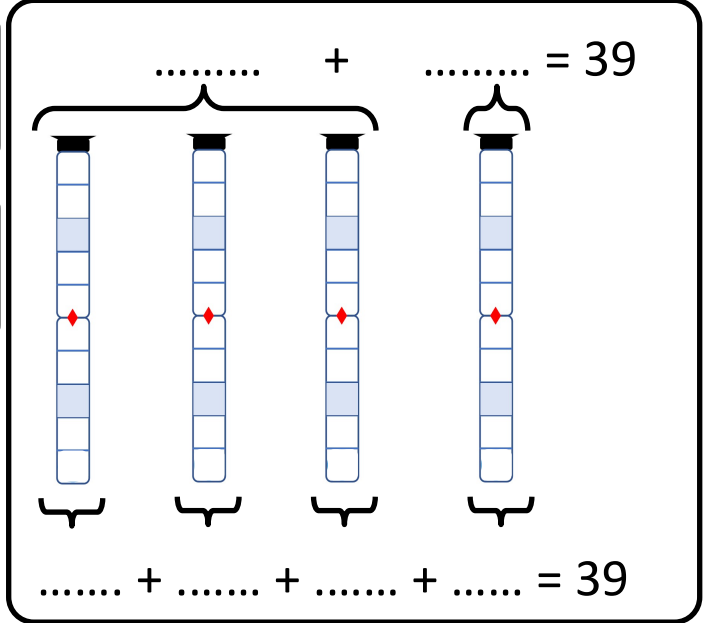

C'est notre quarantième jour de classe

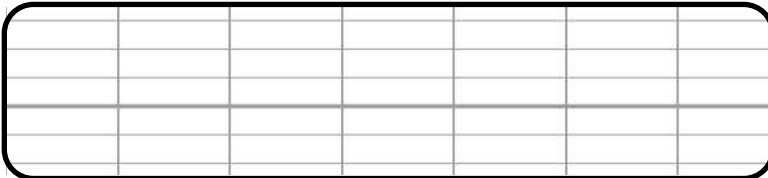

Dizaines: <input type="text"/>	Unités: <input type="text"/>
--------------------------------	------------------------------

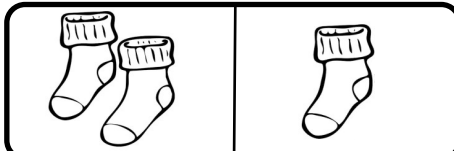

..... < 40 <

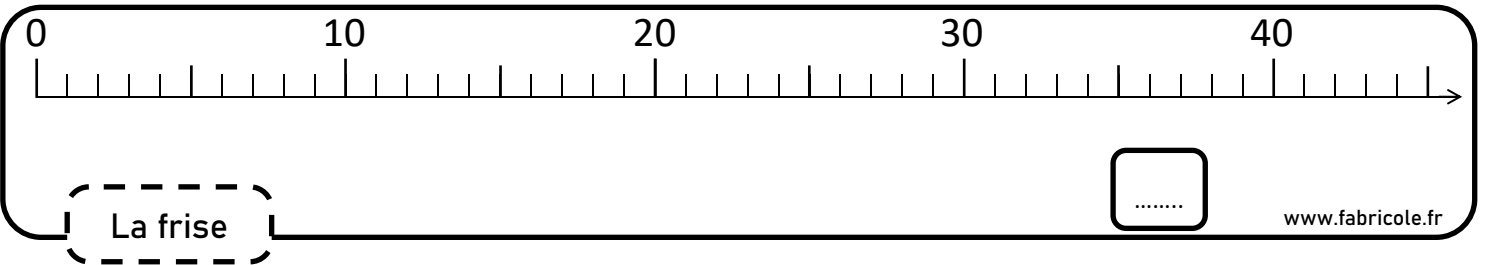
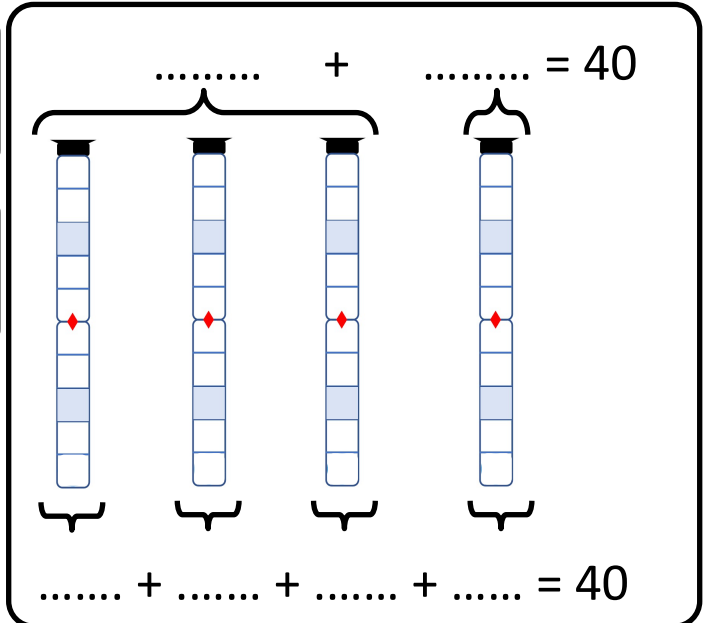

C'est notre quarante-troisième jour de classe

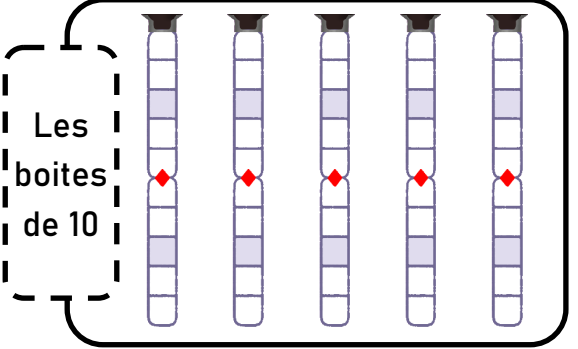
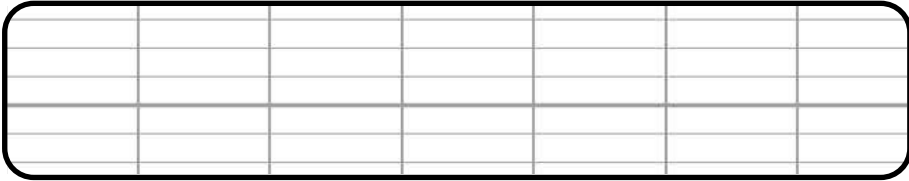

$$43 = 40 + \dots\dots$$

$$43 = 10 + 10 + 10 + 10 + \dots\dots$$

Les décompositions

Dizaines	Unités

..... < 43 <

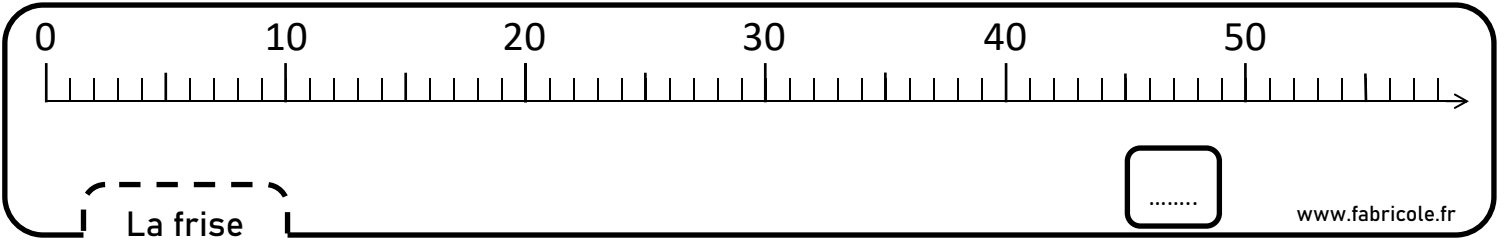
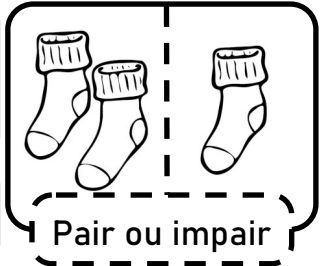

C'est notre quarante-quatrième jour de classe

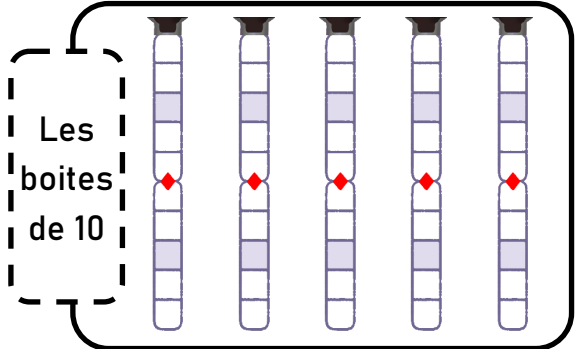
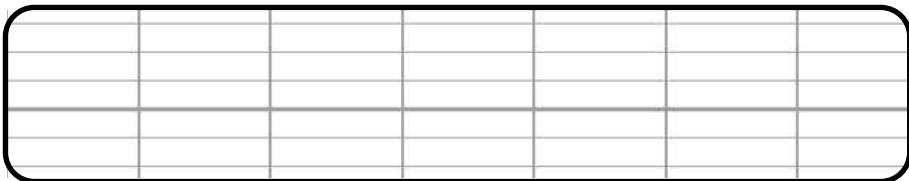

$$44 = 40 + \dots\dots$$

$$44 = 10 + 10 + 10 + 10 + \dots\dots$$

Les décompositions

Dizaines	Unités

..... < 44 <

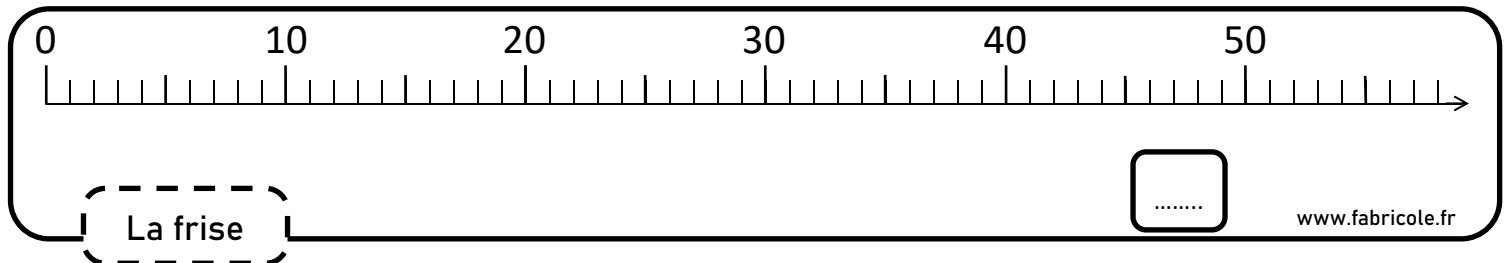
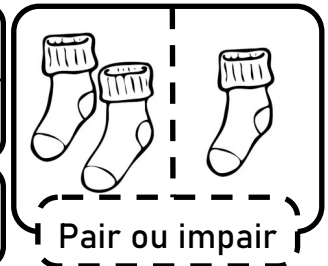

C'est notre quarante-cinquième jour de classe

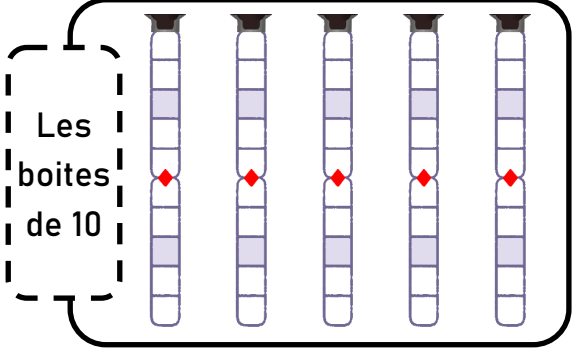
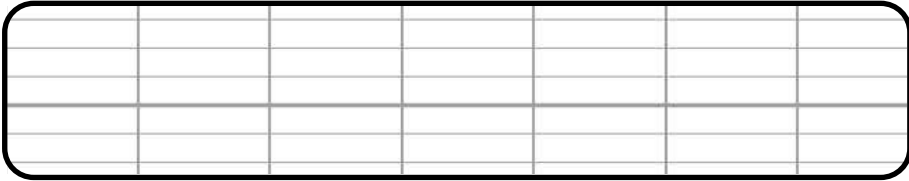

$45 = 40 + \dots$
 $45 = 10 + 10 + 10 + 10 + \dots$

Les décompositions

Dizaines Unités

..... < 45 <

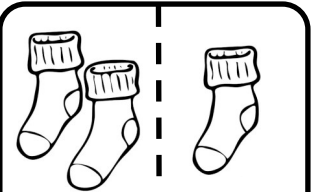

Pair ou impair

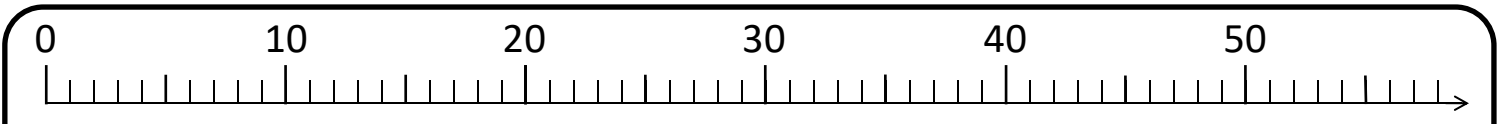

La frise

.....

www.fabricole.fr

C'est notre quarante-sixième jour de classe

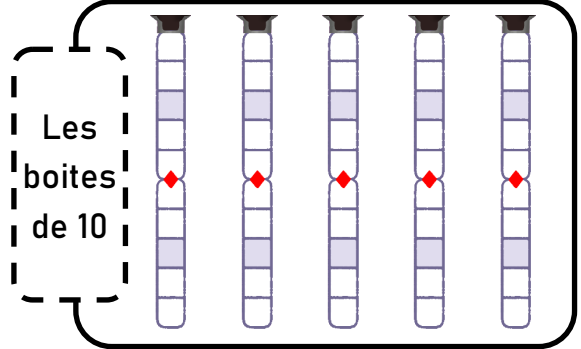
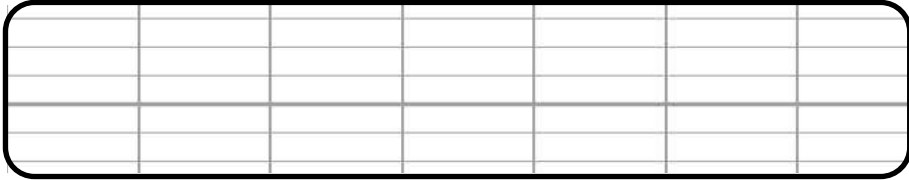

$46 = 40 + \dots$
 $46 = 10 + 10 + 10 + 10 + \dots$

Les décompositions

Dizaines Unités

..... < 46 <

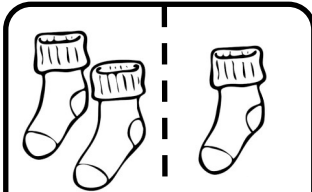

Pair ou impair

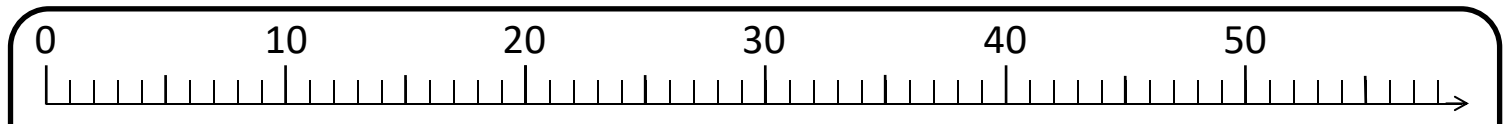

La frise

.....

www.fabricole.fr

C'est notre quarante-septième jour de classe

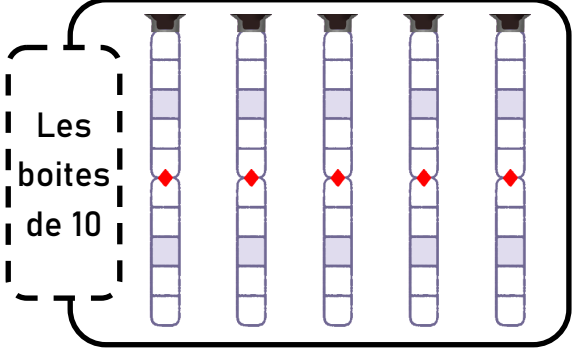
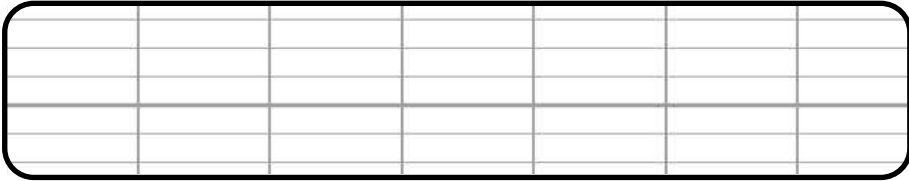

$$47 = 40 + \dots$$

$$47 = 10 + 10 + 10 + 10 + \dots$$

Les décompositions

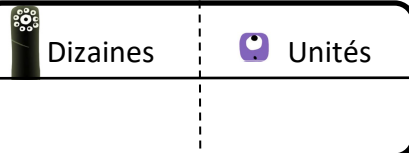

..... < 47 <

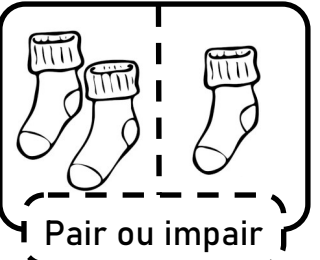

La frise



www.fabricole.fr

C'est notre quarante-huitième jour de classe

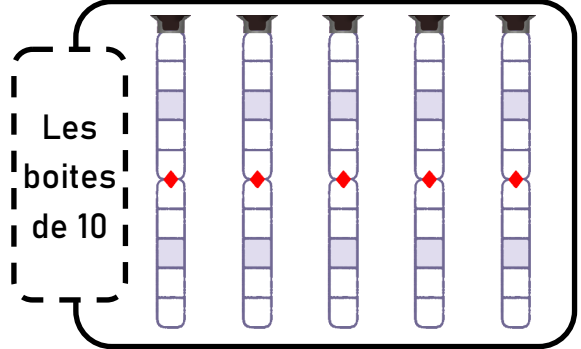
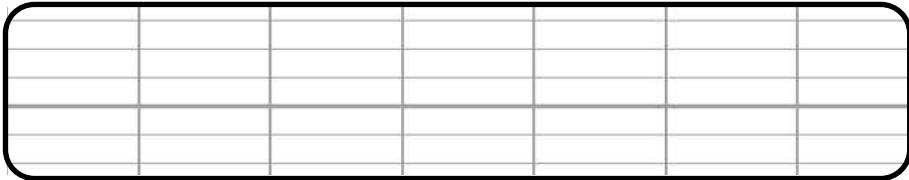

$$48 = 40 + \dots$$

$$48 = 10 + 10 + 10 + 10 + \dots$$

Les décompositions

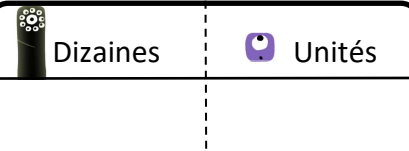

..... < 48 <

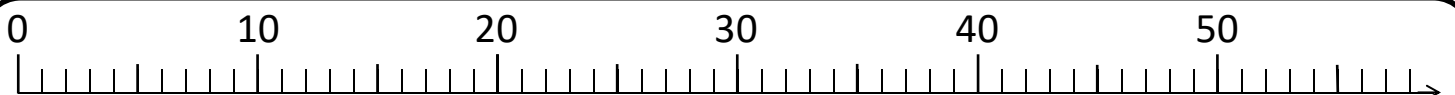
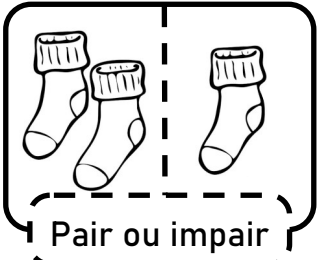

La frise



www.fabricole.fr

C'est notre quarante-neuvième jour de classe

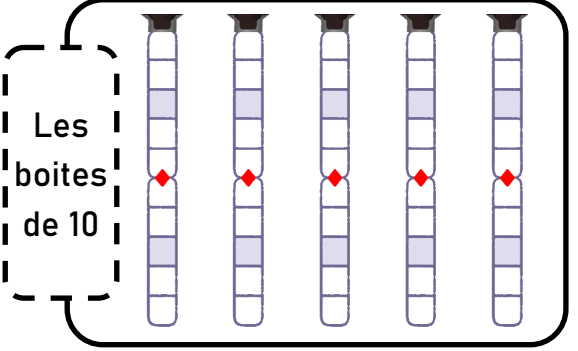
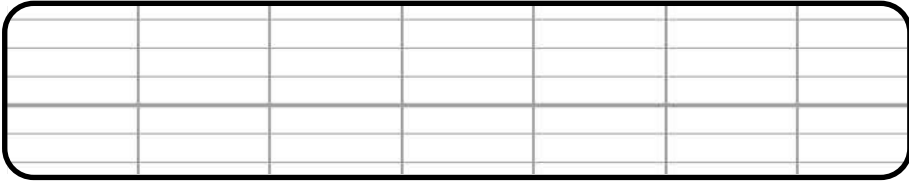

$$49 = 40 + \dots$$

$$49 = 10 + 10 + 10 + 10 + \dots$$

Les décompositions

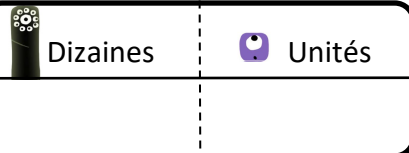

..... < 49 <

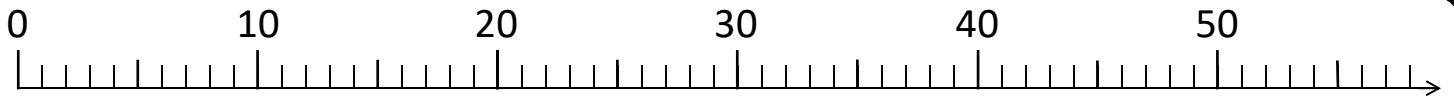
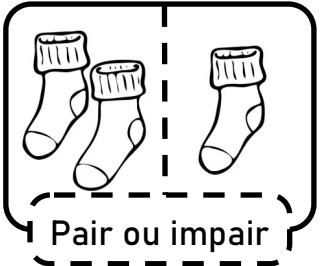

La frise



www.fabricole.fr

C'est notre cinquantième jour de classe

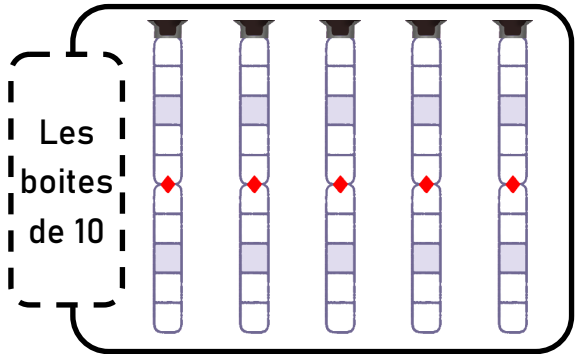
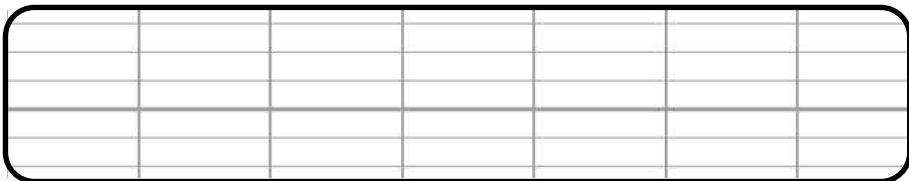

$$50 = 40 + \dots$$

$$50 = 10 + 10 + 10 + 10 + \dots$$

Les décompositions

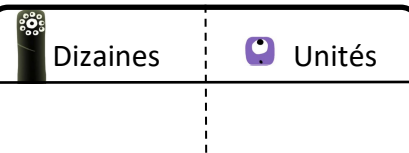

..... < 50 <

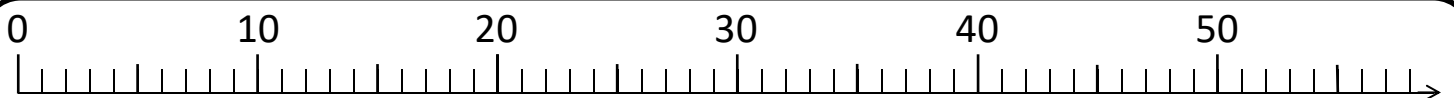
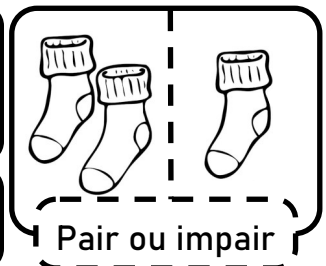



La frise

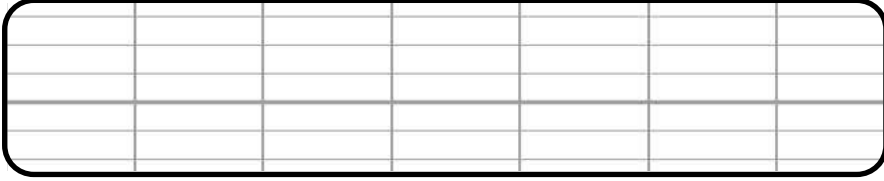

www.fabricole.fr

C'est notre cinquante-et-unième jour de classe.



	
Dizaines	Unités

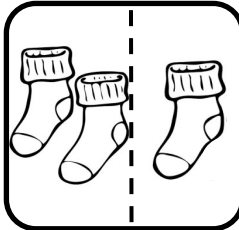

$$51 = \dots + \dots$$
$$\dots < 51 < \dots$$

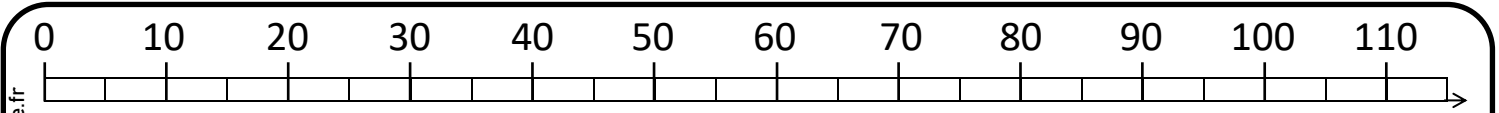
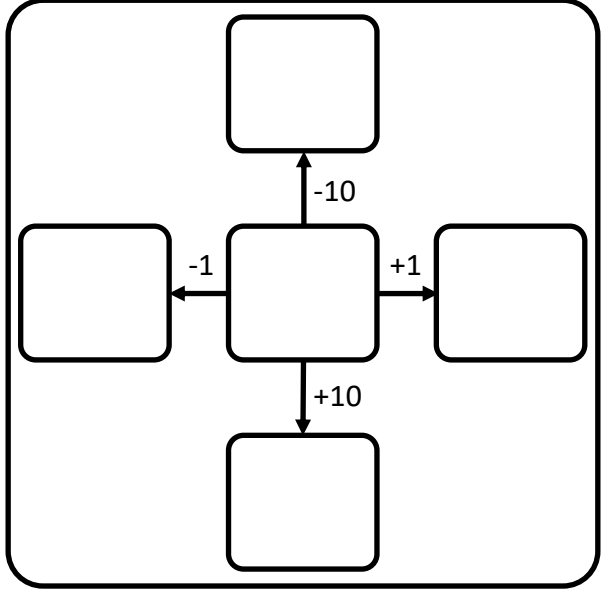

www.fabricole.fr

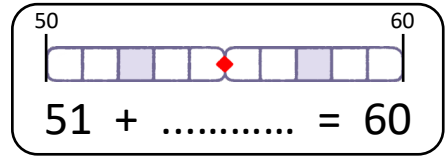

Encadrement sur la frise

C'est notre cinquante-deuxième jour de classe.

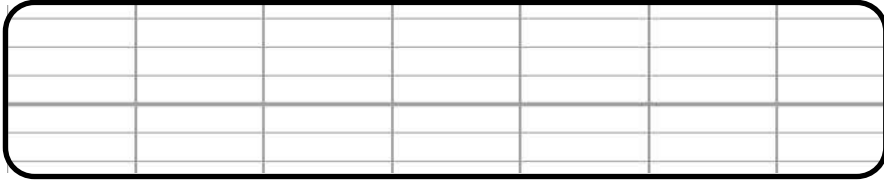

	
Dizaines	Unités

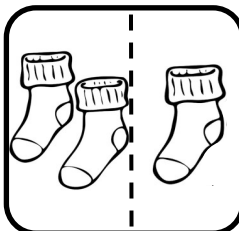

$$52 = \dots + \dots$$
$$\dots < 52 < \dots$$

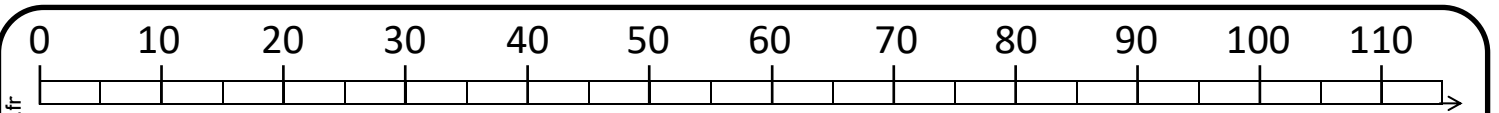
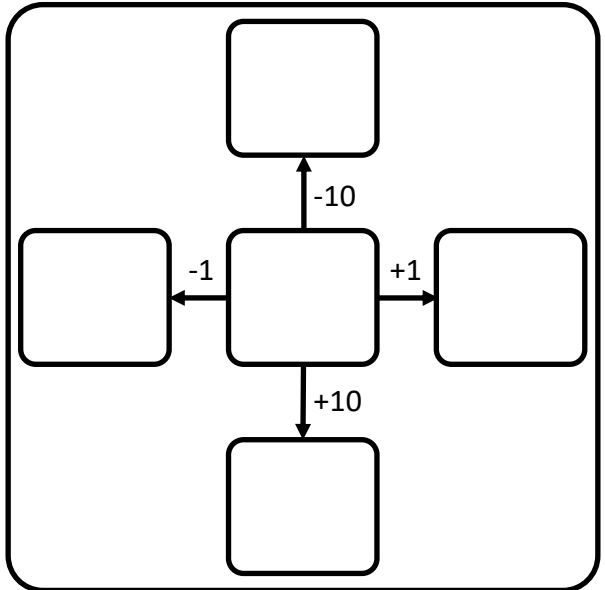

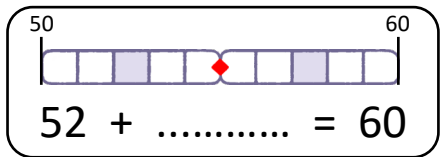

www.fabricole.fr

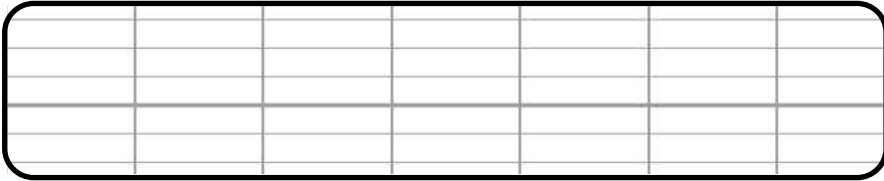

Encadrement sur la frise

C'est notre cinquante-troisième jour de classe.



	
Dizaines	Unités

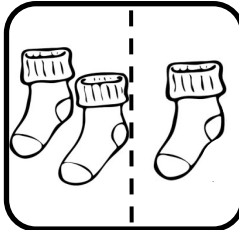

$$53 = \dots + \dots$$
$$\dots < 53 < \dots$$

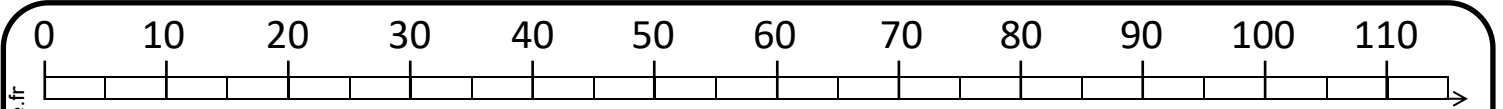
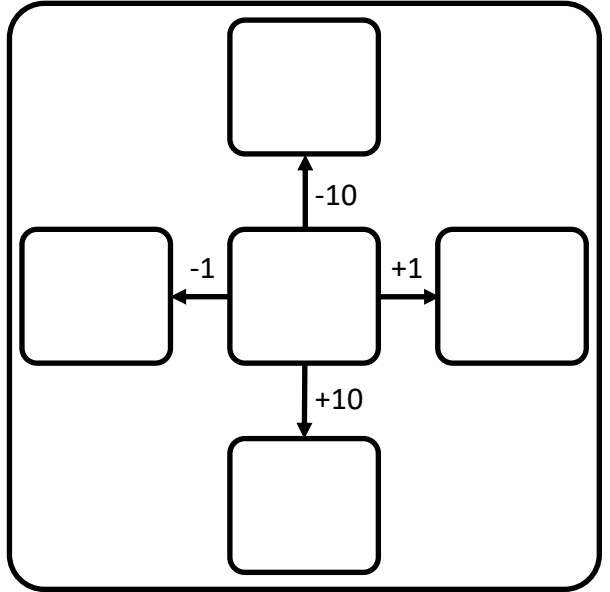

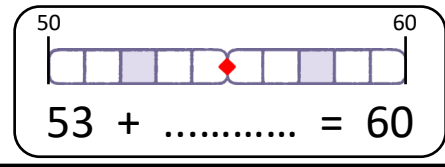

www.fabricole.fr

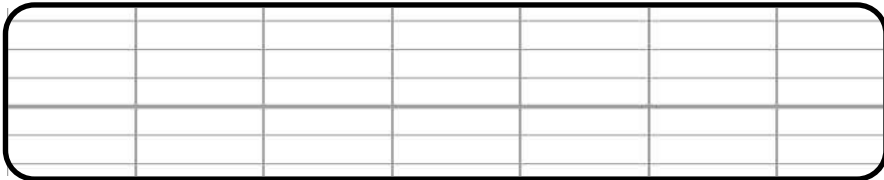

Encadrement sur la frise

C'est notre cinquante-quatrième jour de classe.



	
Dizaines	Unités

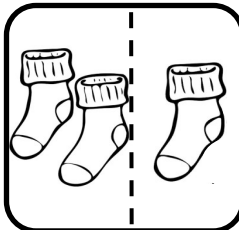

$$54 = \dots + \dots$$
$$\dots < 54 < \dots$$

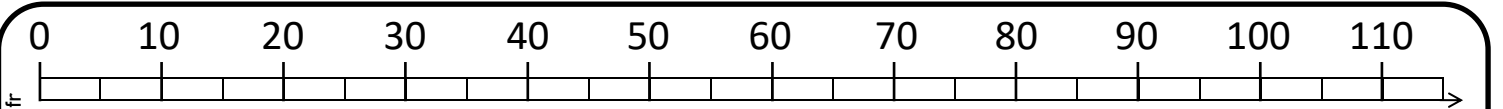
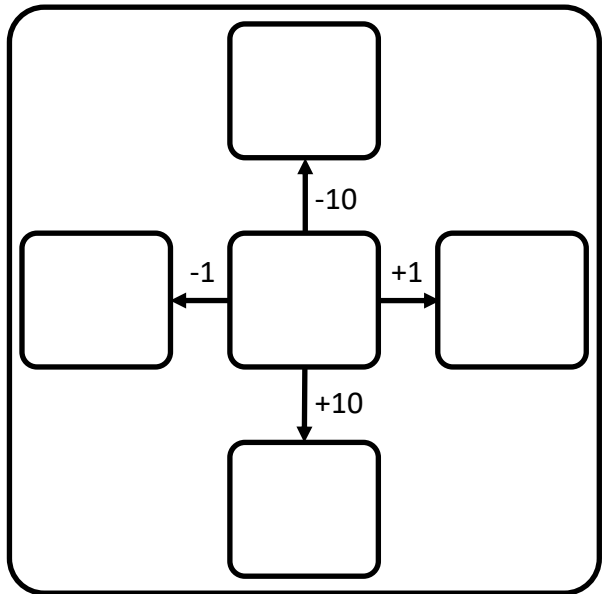

www.fabricole.fr

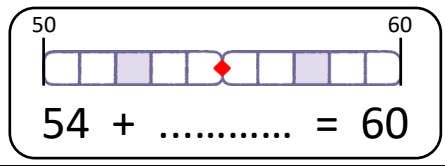

Encadrement sur la frise

C'est notre cinquante-cinquième jour de classe.

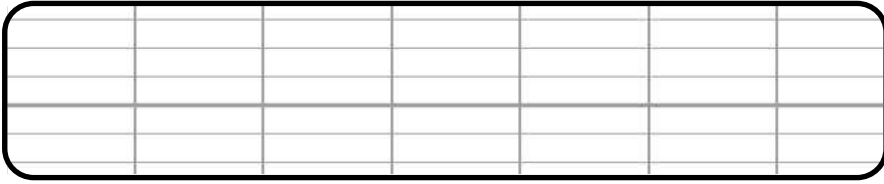

	
Dizaines	Unités

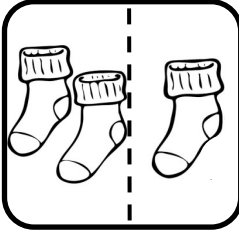

$$55 = \dots + \dots$$
$$\dots < 55 < \dots$$

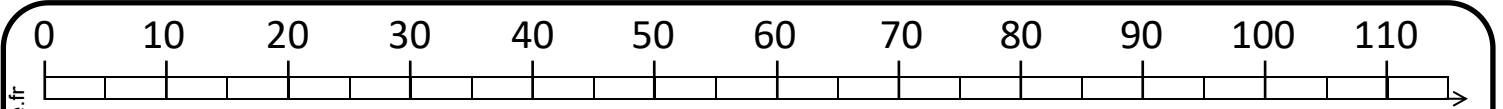
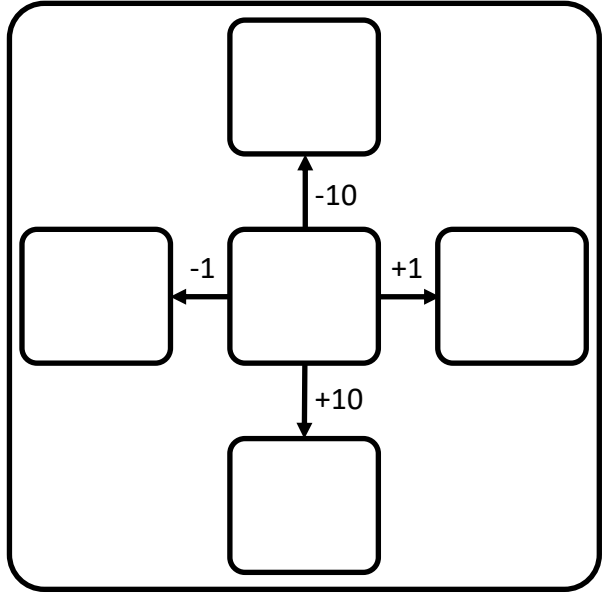

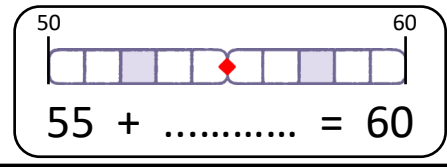

www.fabricole.fr

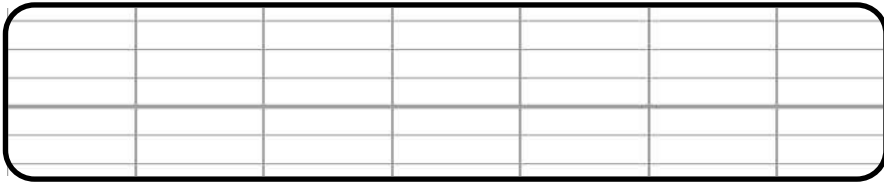

Encadrement sur la frise

C'est notre cinquante-sixième jour de classe.



	
Dizaines	Unités

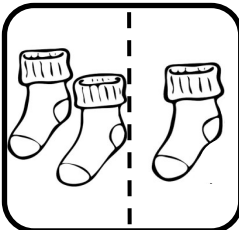

$$56 = \dots + \dots$$
$$\dots < 56 < \dots$$

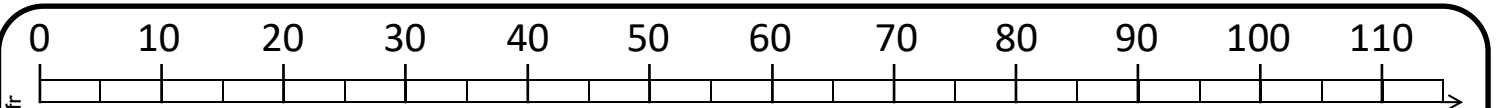
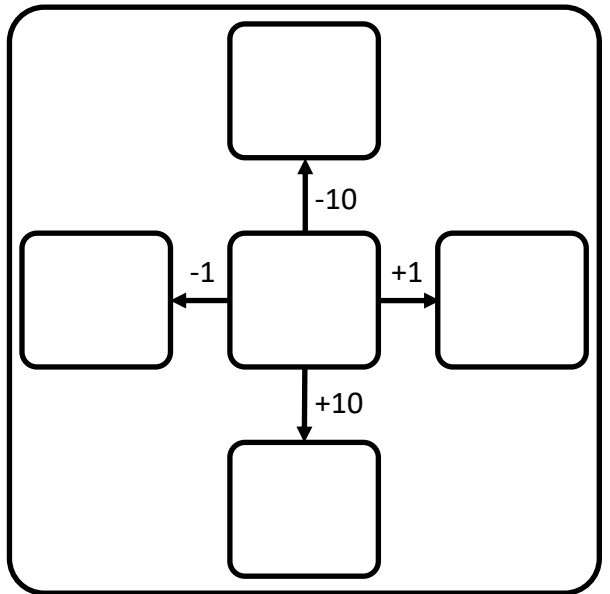

www.fabricole.fr

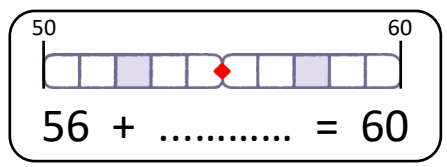

Encadrement sur la frise

C'est notre cinquante-septième jour de classe.

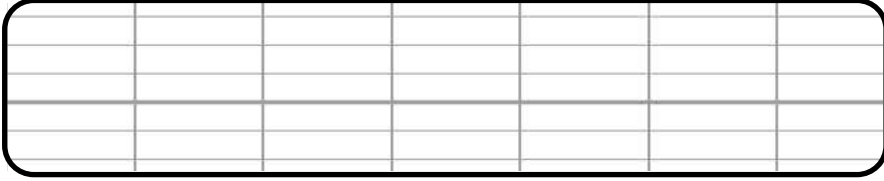

	
Dizaines	Unités

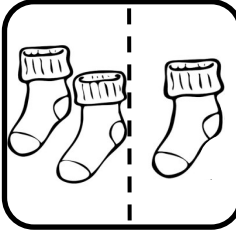

$$57 = \dots + \dots$$
$$\dots < 57 < \dots$$

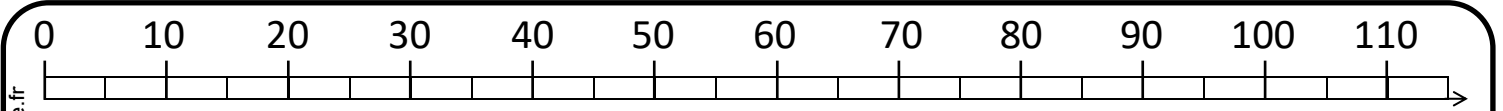
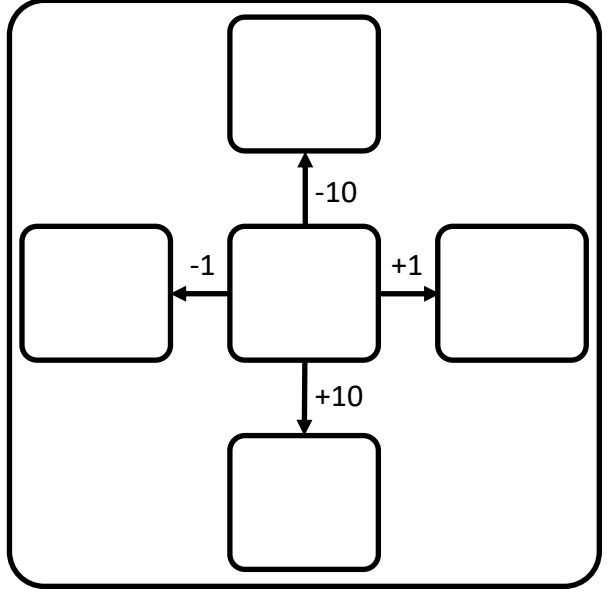

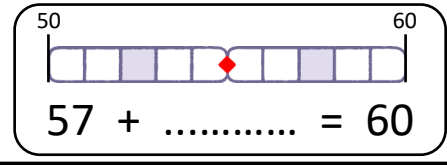

www.fabricole.fr

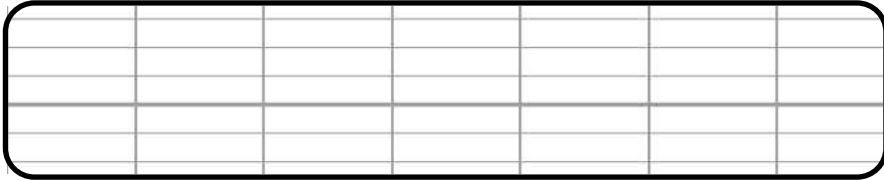

Encadrement sur la frise

C'est notre cinquante-huitième jour de classe.



	
Dizaines	Unités

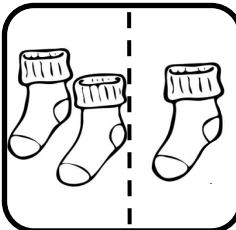

$$58 = \dots + \dots$$
$$\dots < 58 < \dots$$

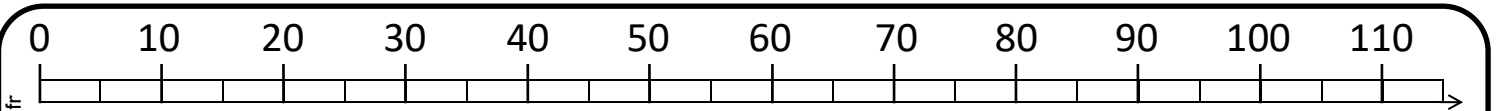
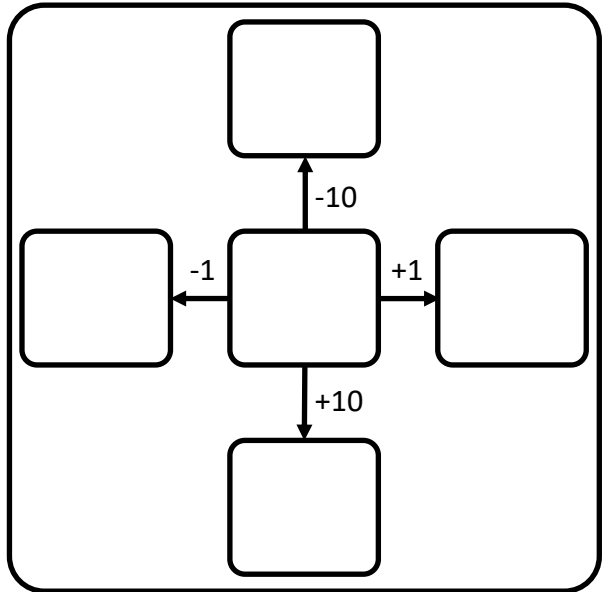

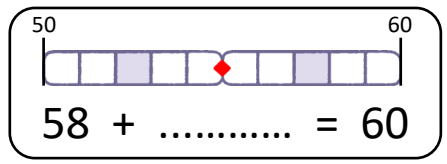

www.fabricole.fr

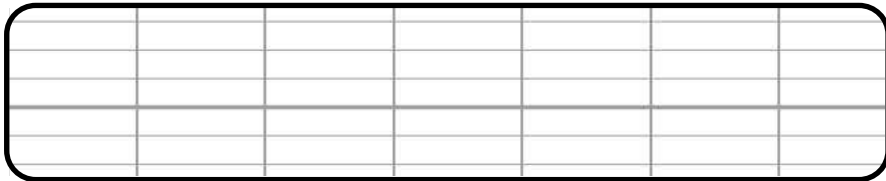

Encadrement sur la frise

C'est notre cinquante-neuvième jour de classe.



	
Dizaines	Unités

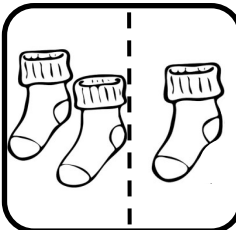

$$59 = \dots + \dots$$
$$\dots < 59 < \dots$$

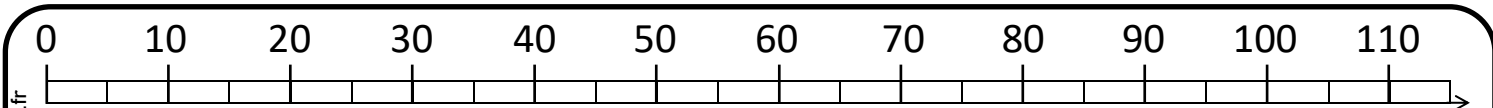
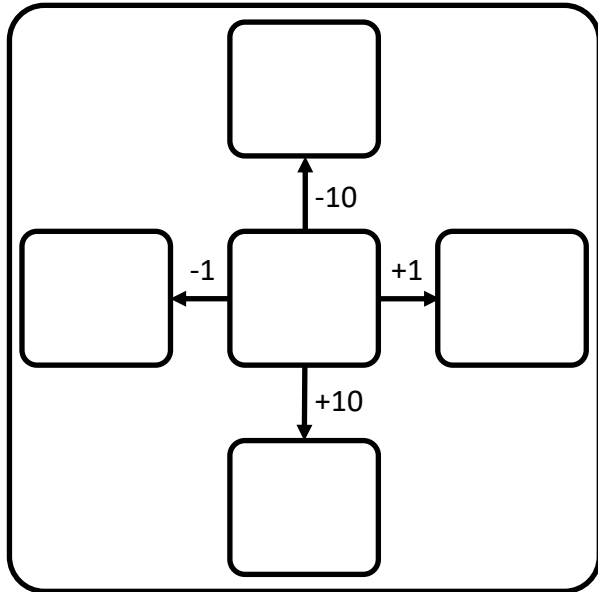

www.fabricole.fr

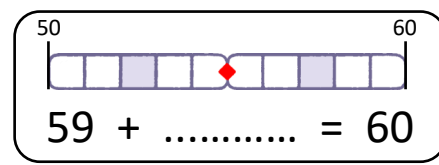

Encadrement sur la frise

C'est notre soixantième jour de classe.

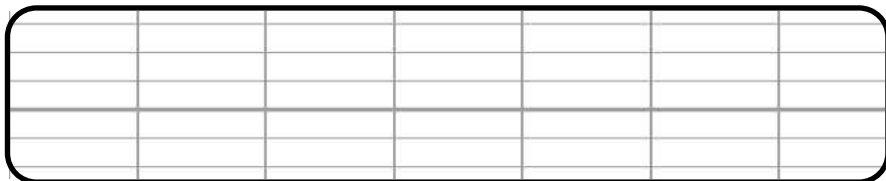

	
Dizaines	Unités

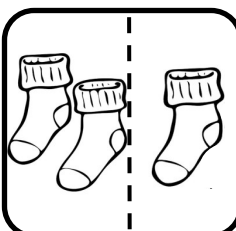

$$60 = 50 + \dots$$
$$\dots < 60 < \dots$$

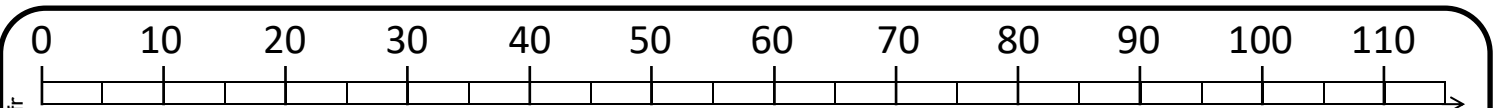
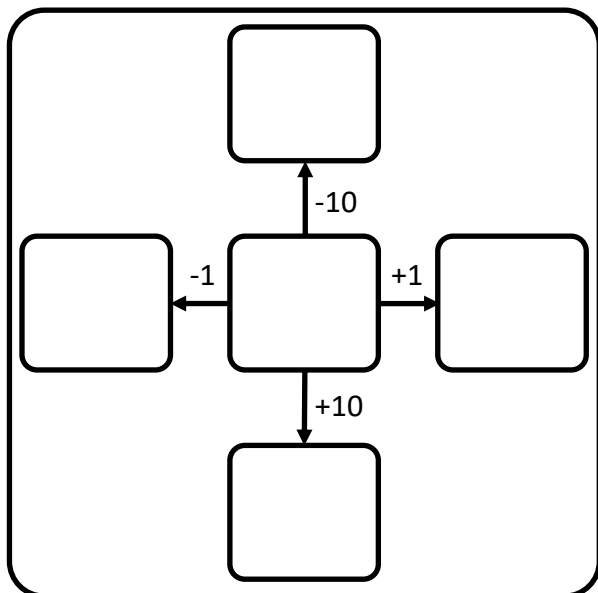

www.fabricole.fr

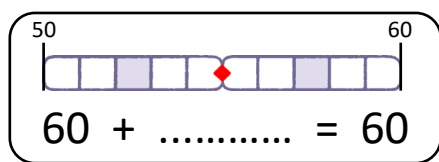

Encadrement sur la frise

C'est notre soixante-et-unième jour de classe.

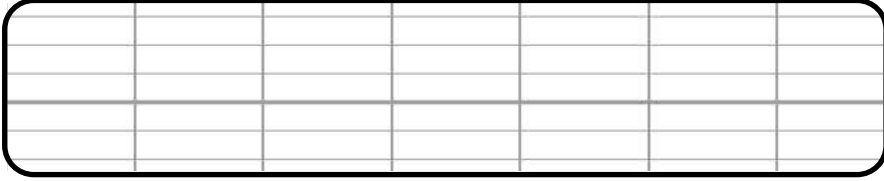

	
Dizaines	Unités



$$61 = \dots + \dots$$
$$\dots < 61 < \dots$$

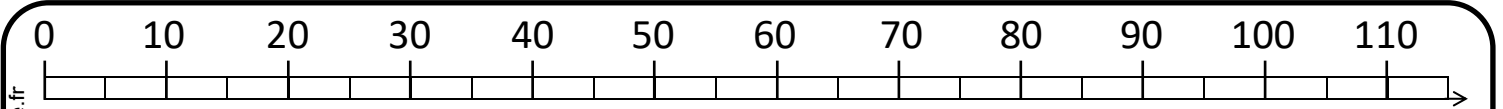
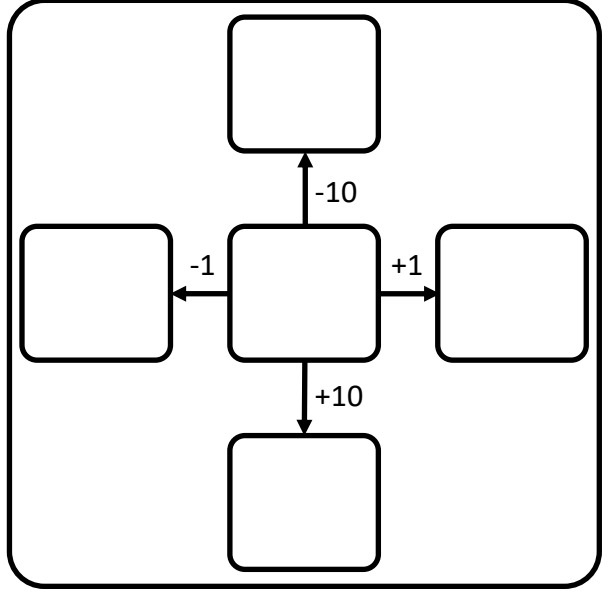

www.fabricole.fr

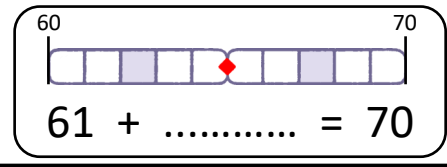

Encadrement sur la frise

C'est notre soixante-deuxième jour de classe.

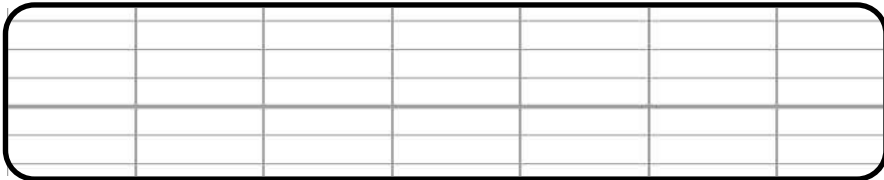

	
Dizaines	Unités

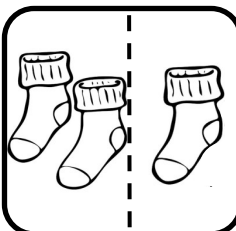

$$62 = \dots + \dots$$
$$\dots < 62 < \dots$$

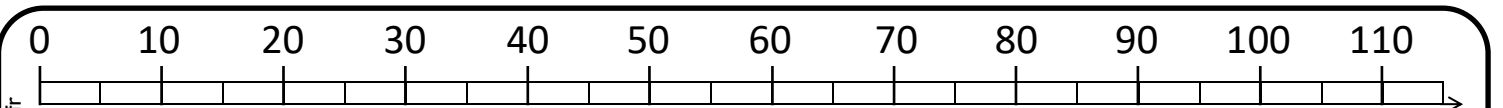
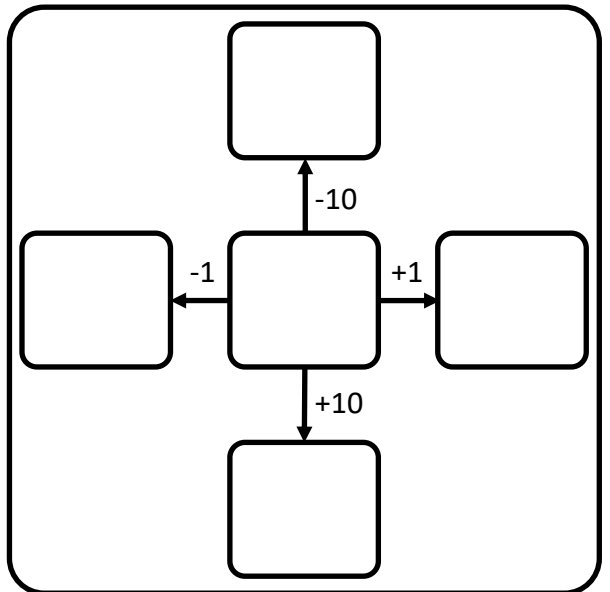

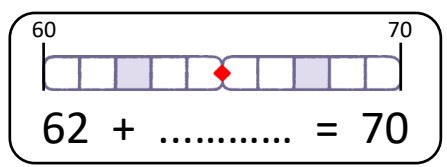

www.fabricole.fr

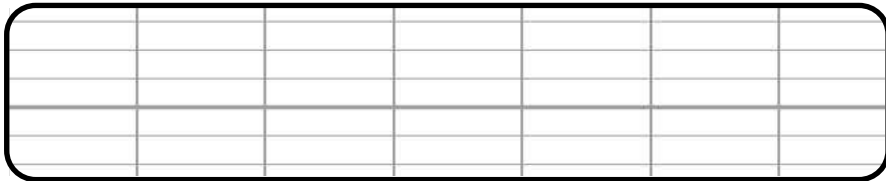

Encadrement sur la frise

C'est notre soixante-troisième jour de classe.



	
Dizaines	Unités

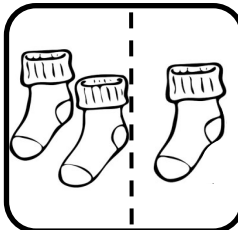

$$63 = \dots + \dots$$
$$\dots < 63 < \dots$$

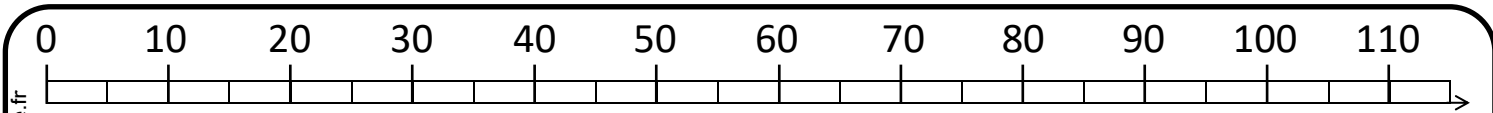
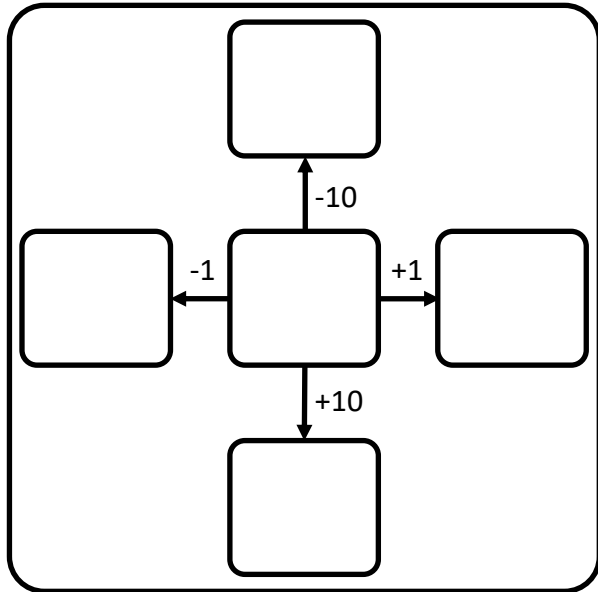

www.fabricole.fr

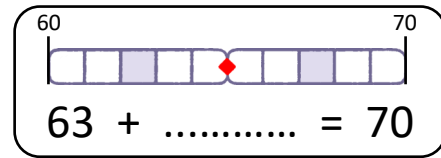

Encadrement sur la frise

C'est notre soixante-troisième jour de classe.

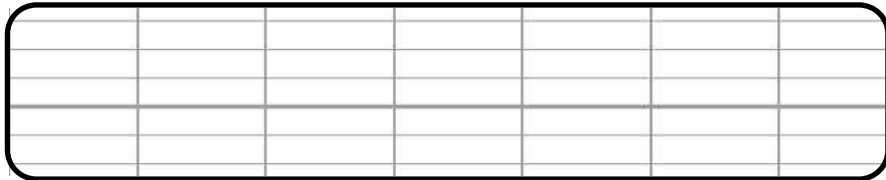

	
Dizaines	Unités

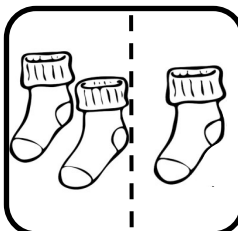

$$64 = \dots + \dots$$
$$\dots < 64 < \dots$$

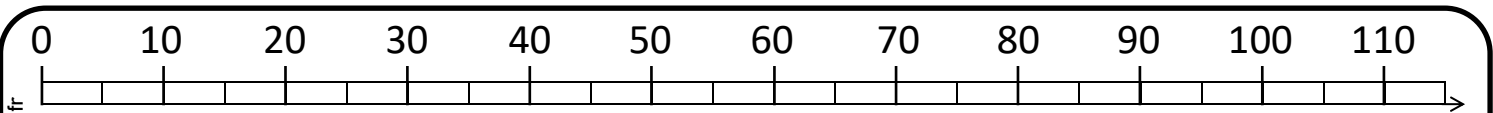
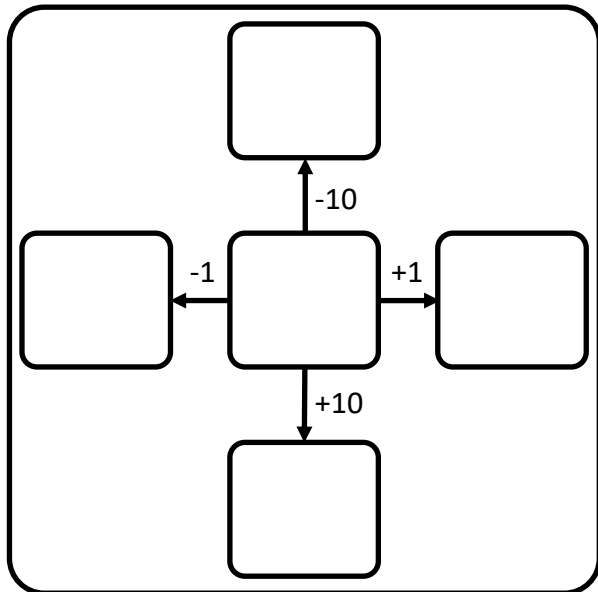

www.fabricole.fr

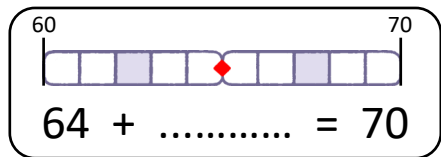

Encadrement sur la frise

C'est notre soixante-cinquième jour de classe.

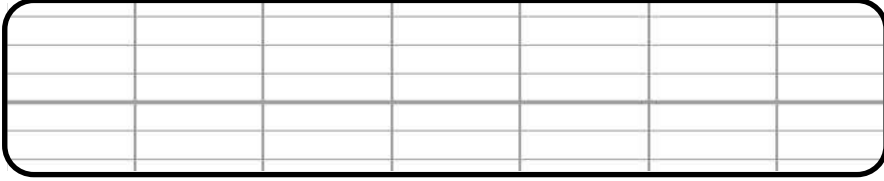

Dizaines	Unités



$$65 = \dots + \dots$$
$$\dots < 65 < \dots$$

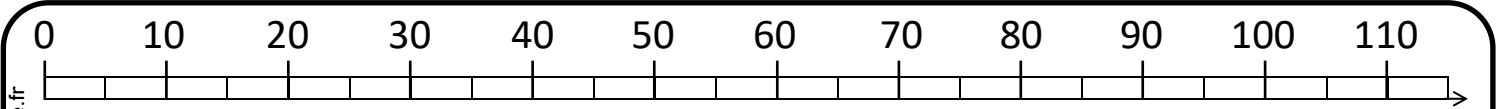
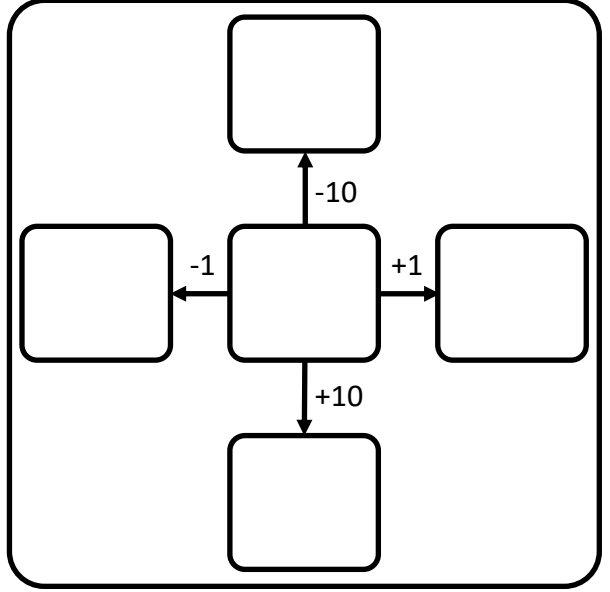

www.fabricole.fr

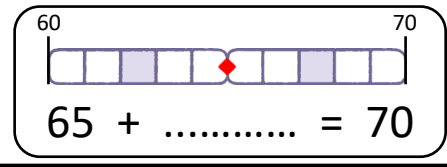

Encadrement sur la frise

C'est notre soixante-sixième jour de classe.

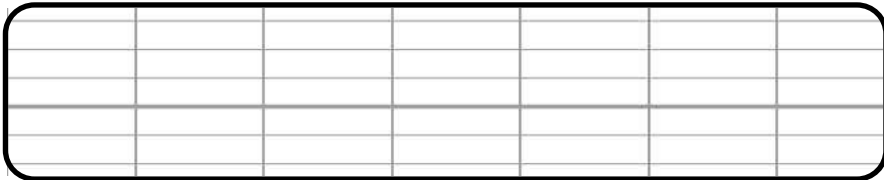

Dizaines	Unités

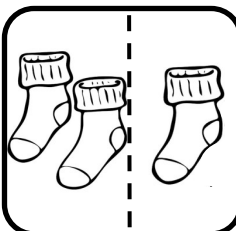

$$66 = \dots + \dots$$
$$\dots < 66 < \dots$$

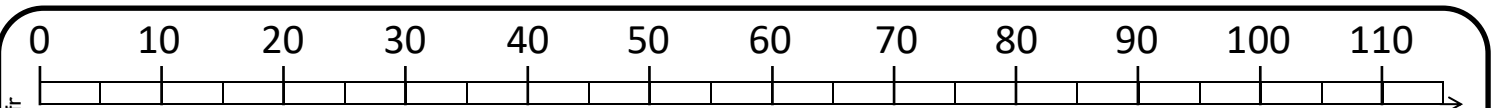
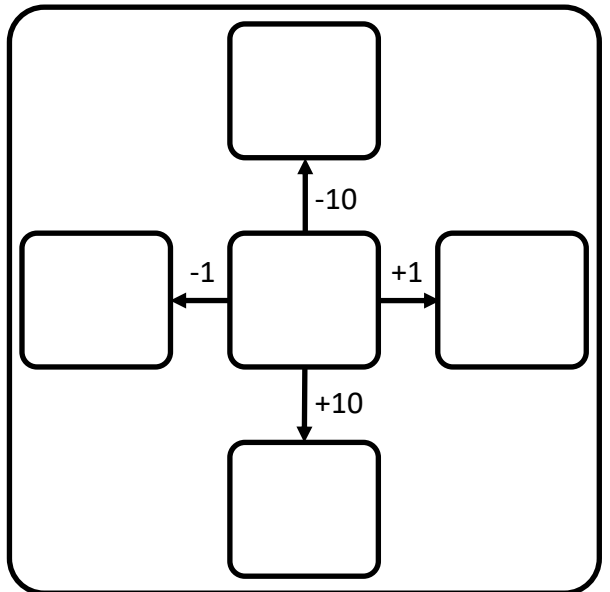

www.fabricole.fr

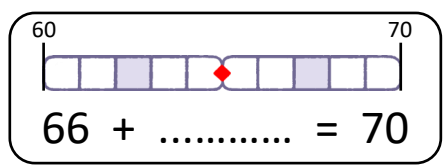

Encadrement sur la frise

C'est notre soixante-septième jour de classe.

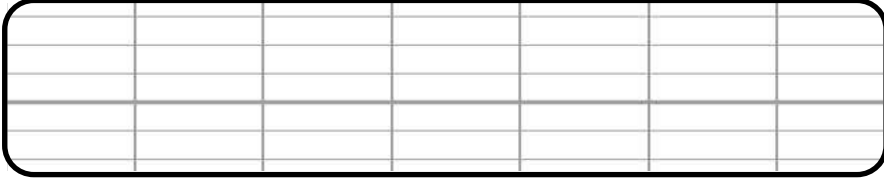

Dizaines	Unités

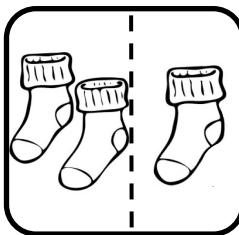

$67 = \dots + \dots$
 $\dots < 67 < \dots$

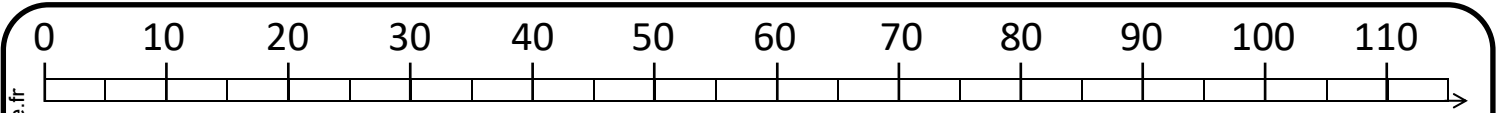
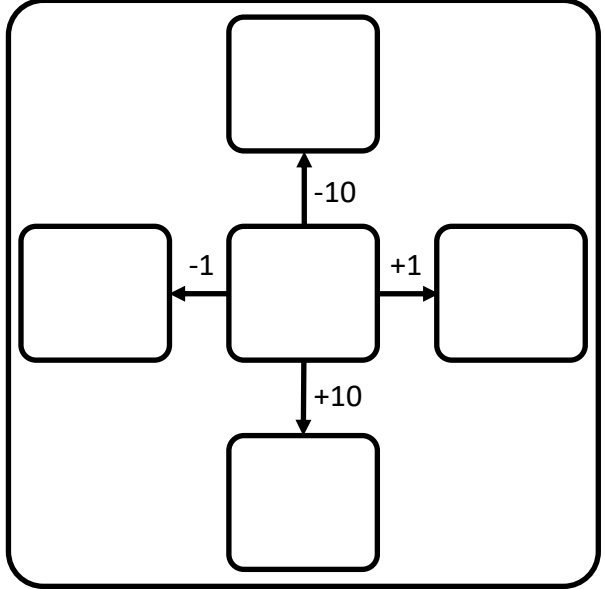

www.fabricole.fr

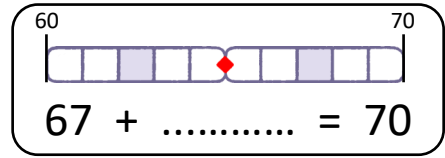

Encadrement sur la frise

.....

C'est notre soixante-huitième jour de classe.

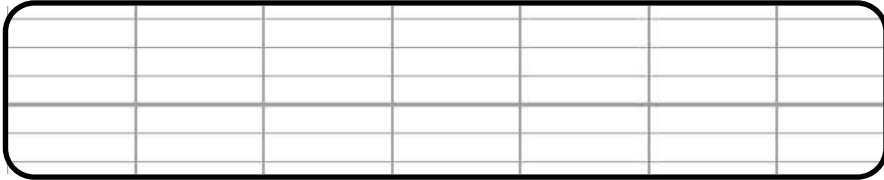

Dizaines	Unités

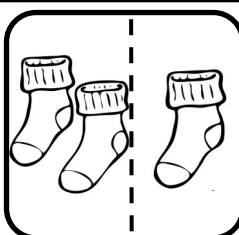

$68 = \dots + \dots$
 $\dots < 68 < \dots$

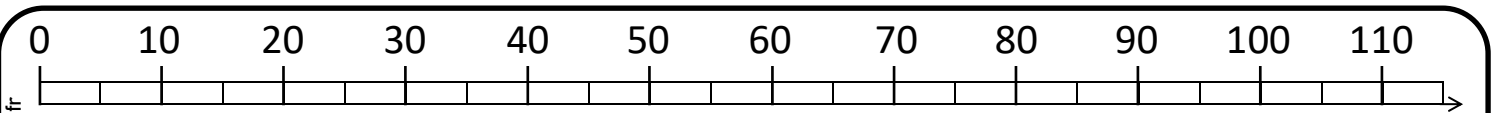
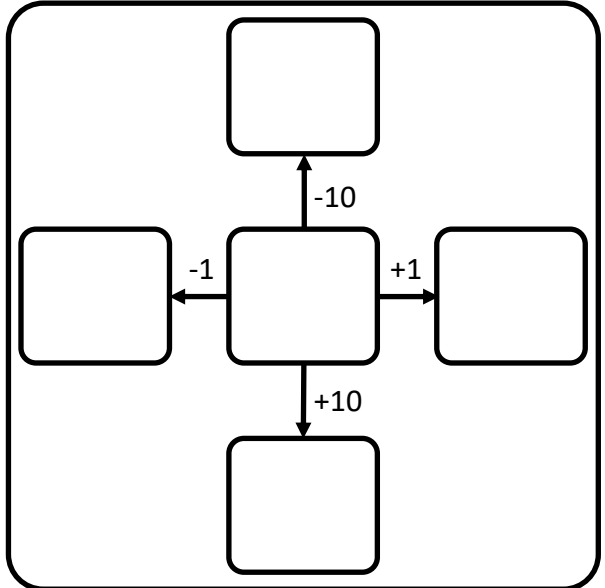

www.fabricole.fr

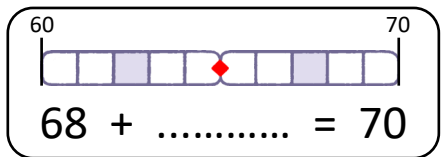



Encadrement sur la frise

.....

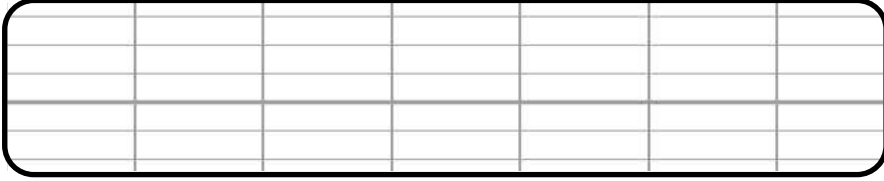
C'est notre soixante-neuvième jour de classe.



	
Dizaines	Unités

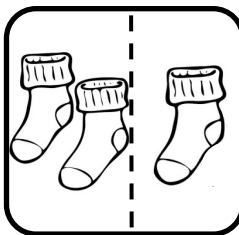

$69 = \dots + \dots$
 $\dots < 69 < \dots$

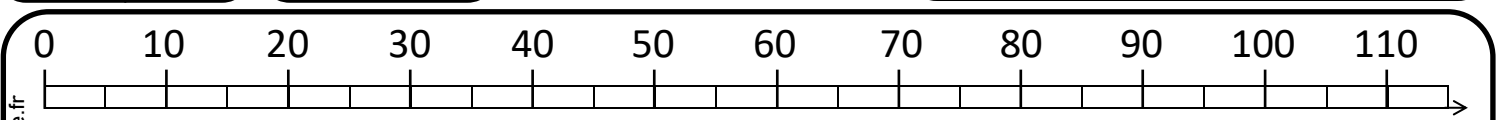
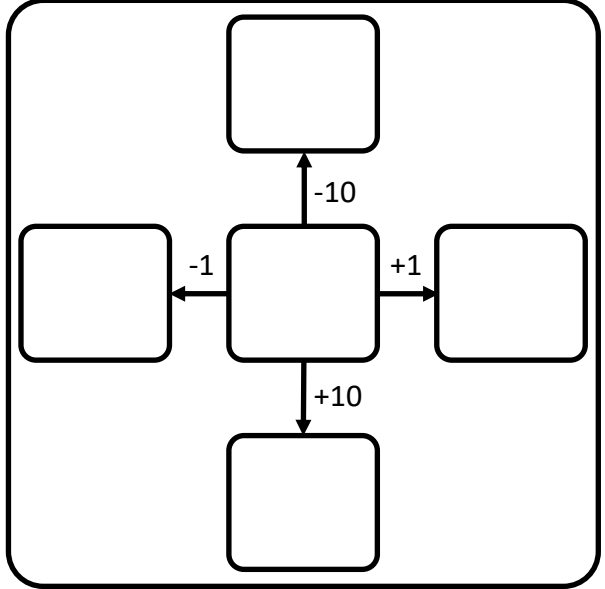

www.fabricole.fr

Encadrement sur la frise

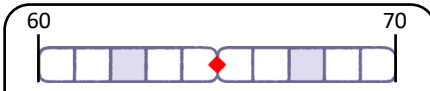

$69 + \dots = 70$

C'est notre soixante-dixième jour de classe.

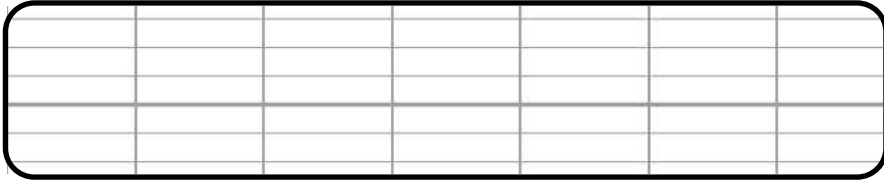

	
Dizaines	Unités

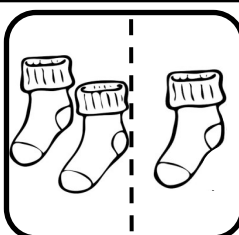

$70 = 60 + \dots$
 $\dots < 70 < \dots$

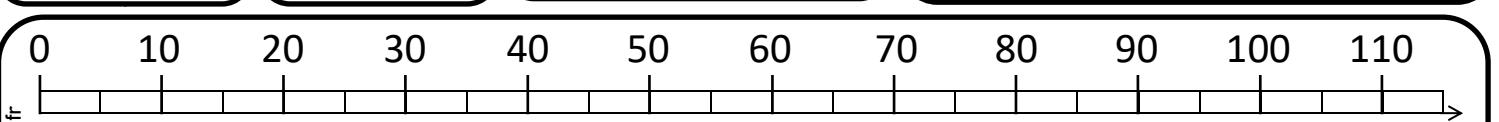
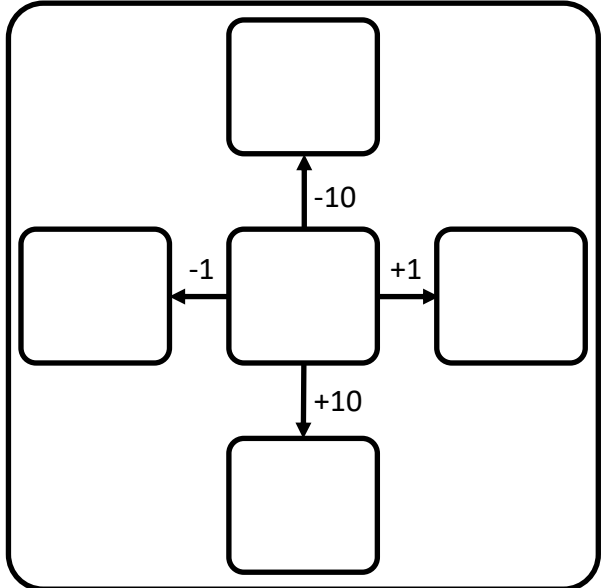

www.fabricole.fr

Encadrement sur la frise

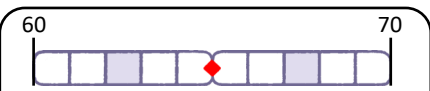

$70 + \dots = 70$

C'est notre soixante-et-onzième jour de classe.

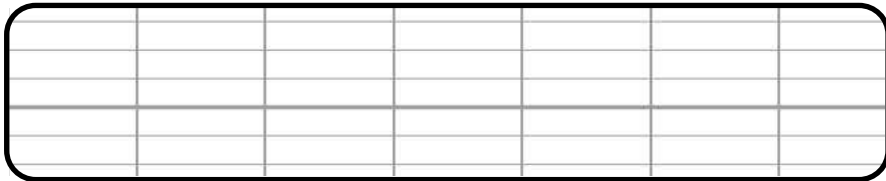

Dizaines	Unités

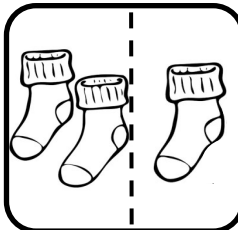

$71 = \dots + \dots$
 $\dots < 71 < \dots$

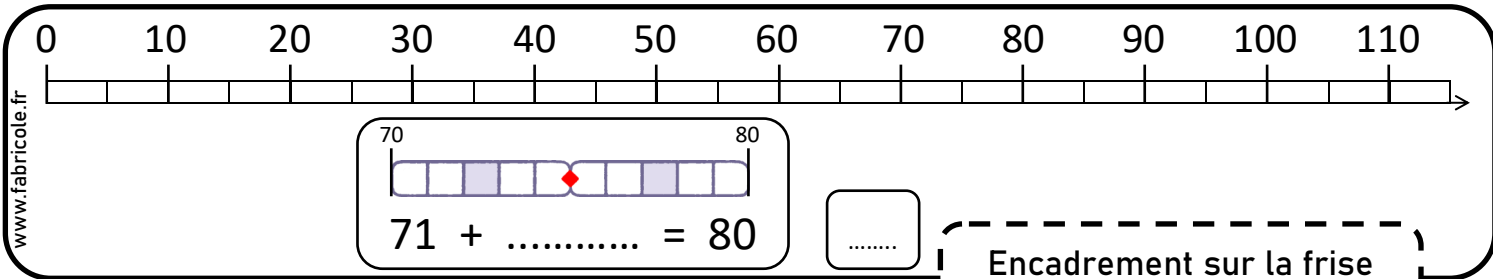
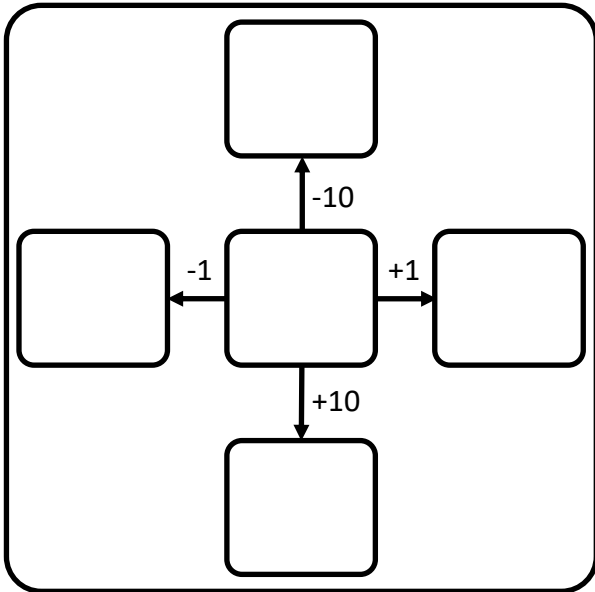

C'est notre soixante-douzième jour de classe.

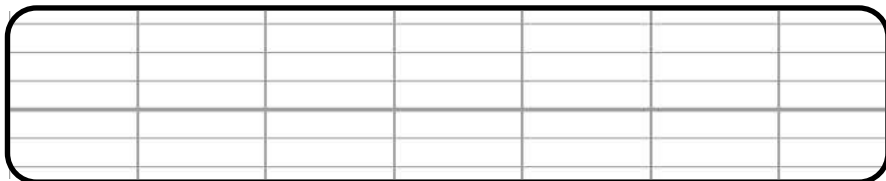

Dizaines	Unités

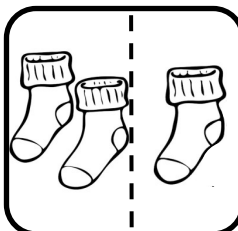

$72 = \dots + \dots$
 $\dots < 72 < \dots$

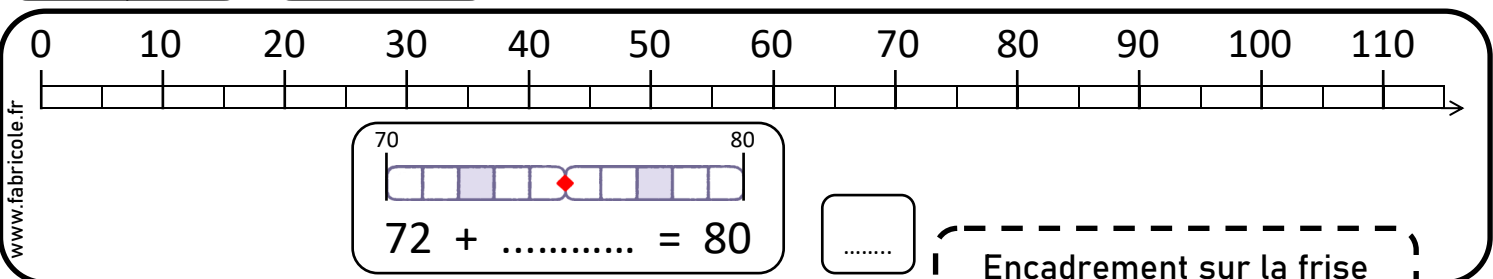
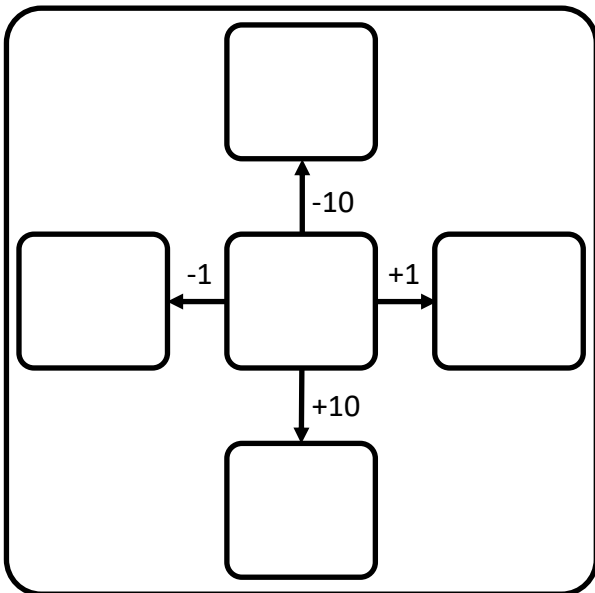

C'est notre soixante-treizième jour de classe.

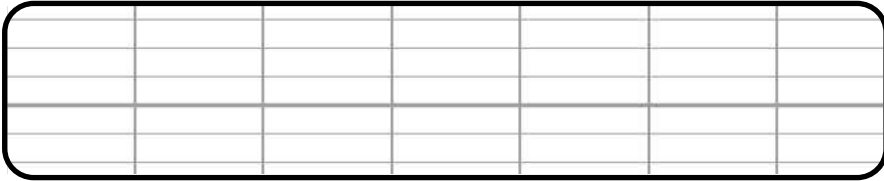

Dizaines	Unités

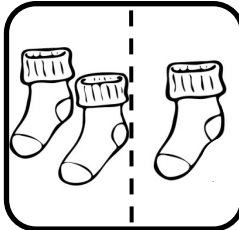

$73 = \dots + \dots$
 $\dots < 73 < \dots$

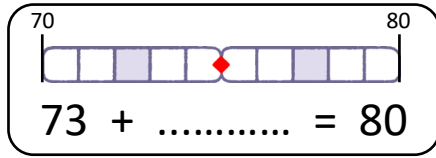
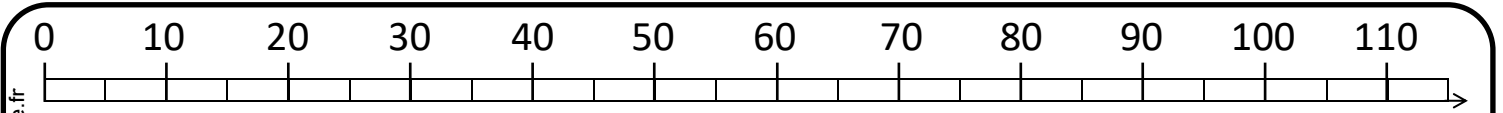
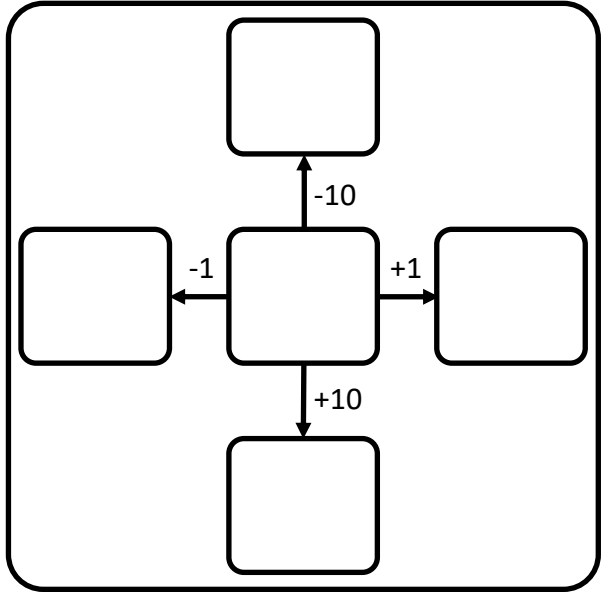

.....

Encadrement sur la frise

C'est notre soixante-quatorzième jour de classe.

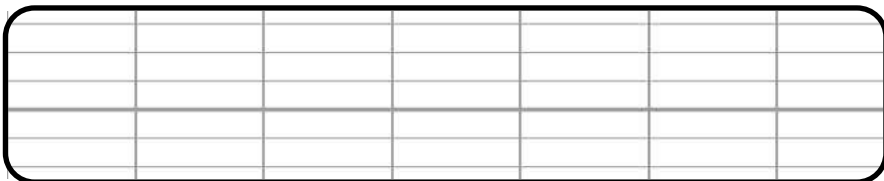

Dizaines	Unités

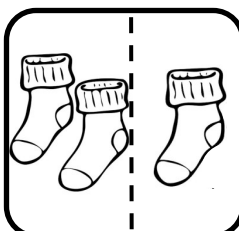

$74 = \dots + \dots$
 $\dots < 74 < \dots$

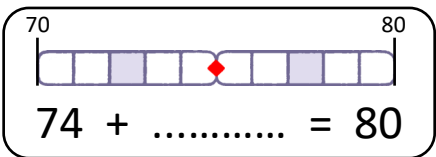
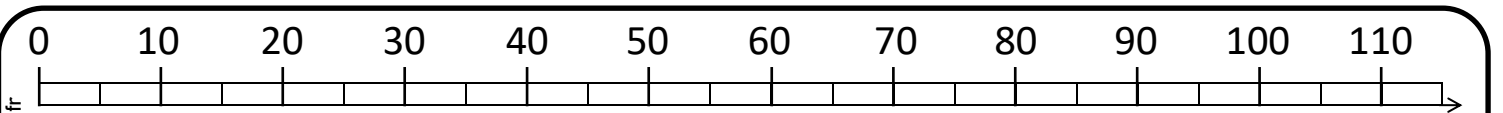
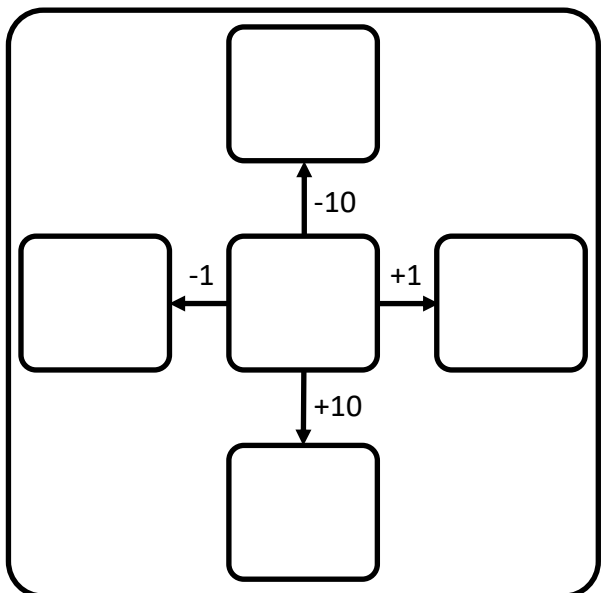

.....

Encadrement sur la frise

C'est notre soixante-quinzième jour de classe.

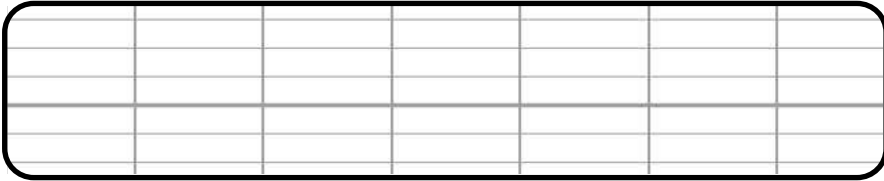

Dizaines	Unités

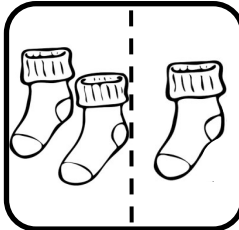

$75 = \dots + \dots$
 $\dots < 75 < \dots$

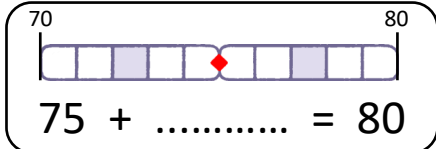
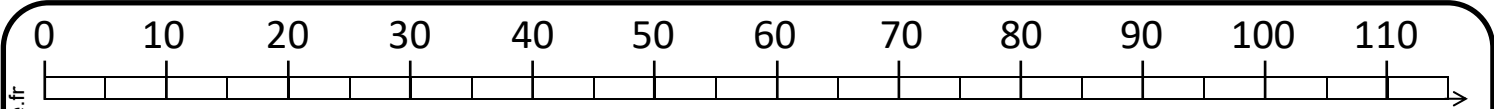
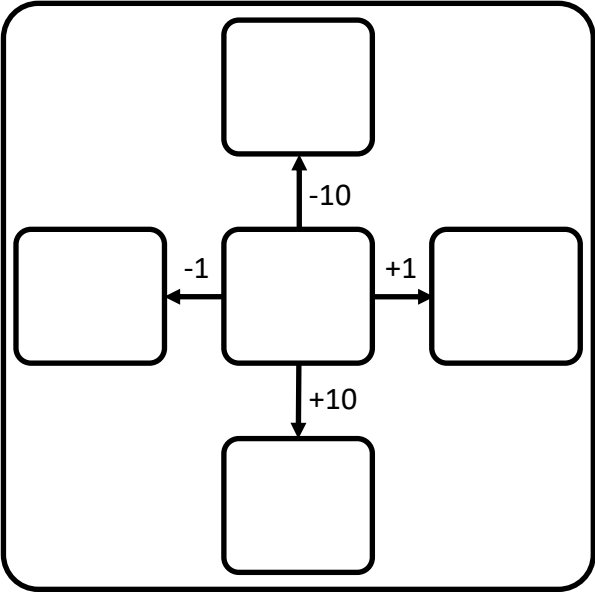

.....

Encadrement sur la frise

C'est notre soixante-seizième jour de classe.

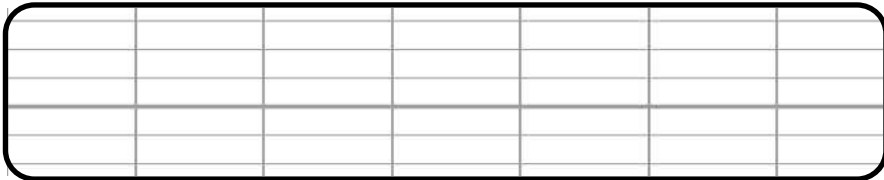

Dizaines	Unités

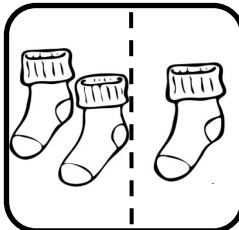

$76 = \dots + \dots$
 $\dots < 76 < \dots$

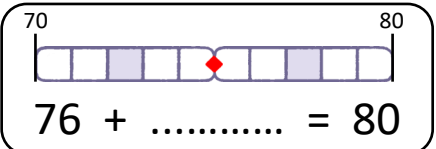
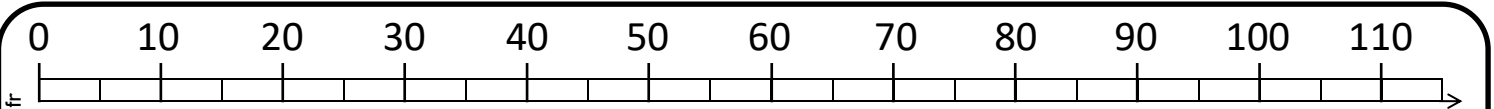
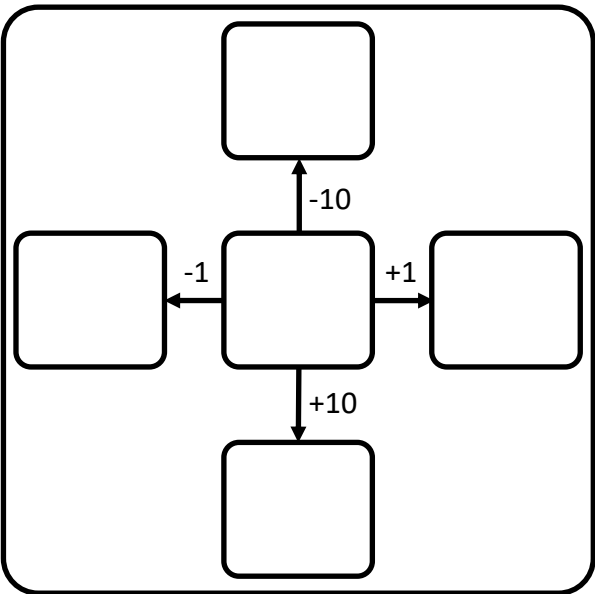



.....

Encadrement sur la frise

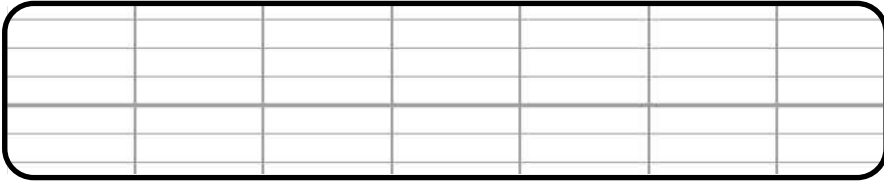
C'est notre soixante-dix-septième jour de classe.



	
Dizaines	Unités

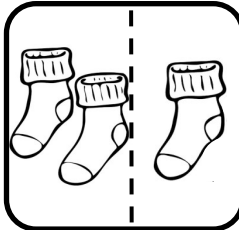

$77 = \dots + \dots$
 $\dots < 77 < \dots$

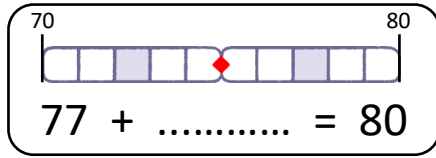
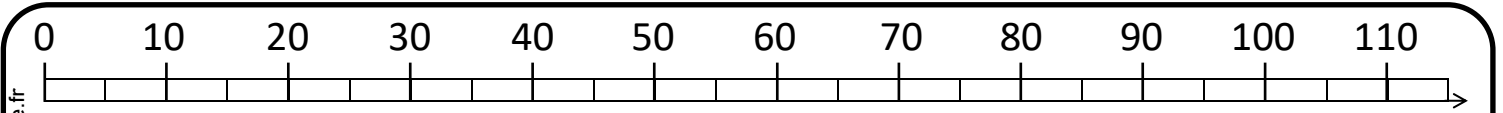
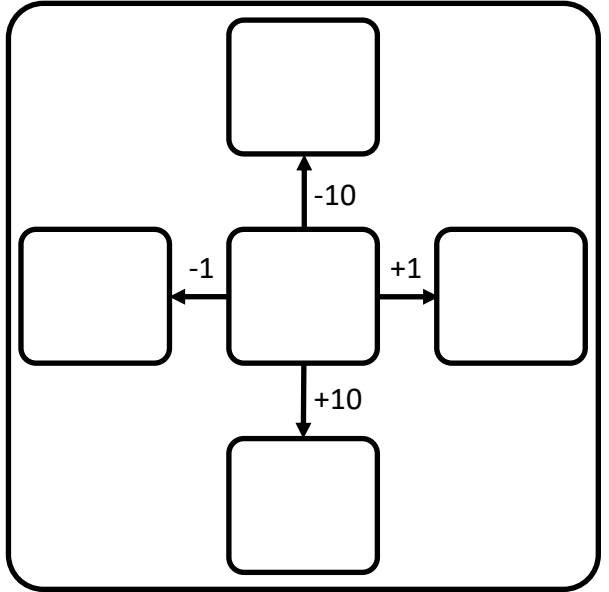

..... Encadrement sur la frise

C'est notre soixante-dix-huitième jour de classe.

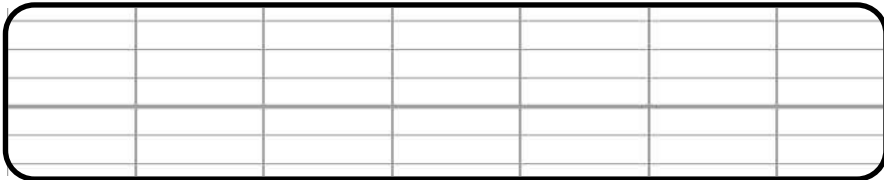

	
Dizaines	Unités

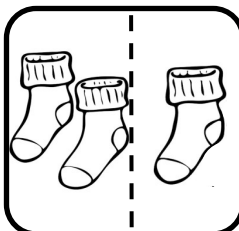

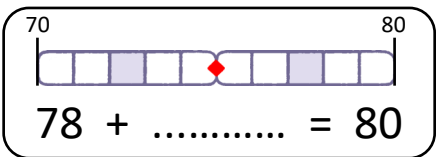
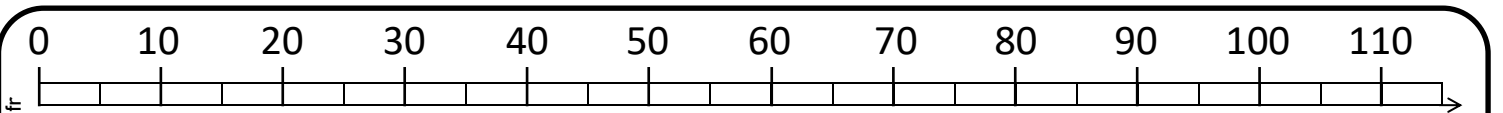
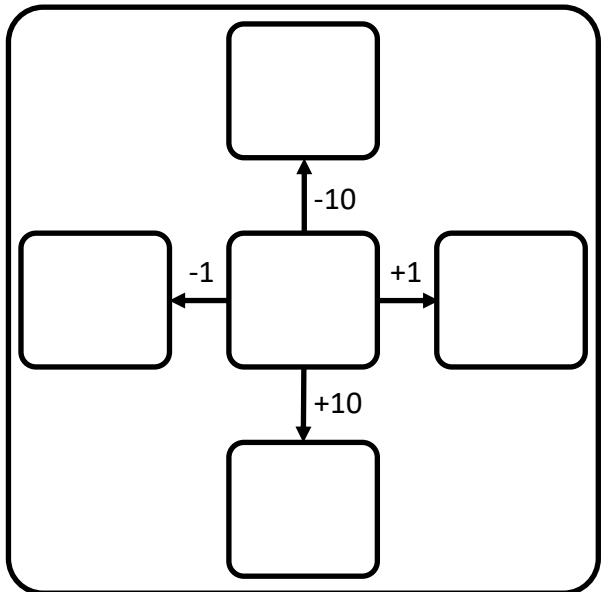

$78 = \dots + \dots$
 $\dots < 78 < \dots$

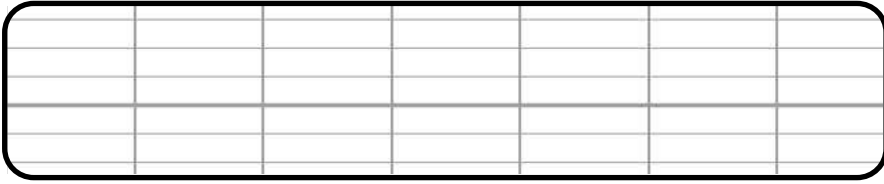

..... Encadrement sur la frise

C'est notre soixante-dix-neuvième jour de classe.



	
Dizaines	Unités

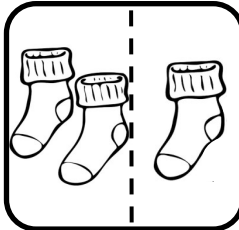

$$79 = \dots + \dots$$
$$\dots < 79 < \dots$$

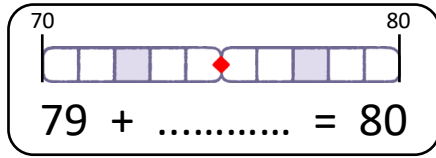
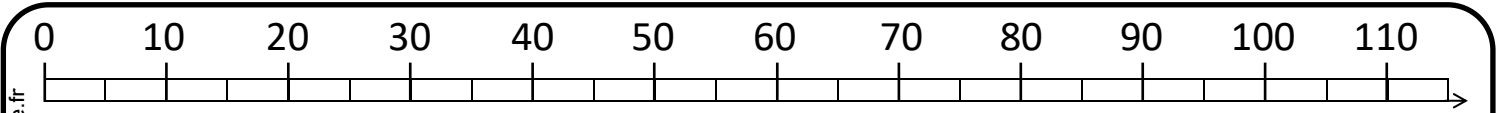
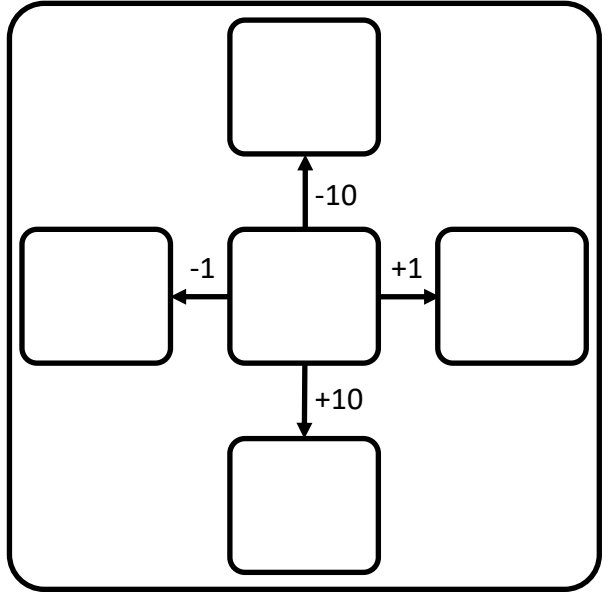

..... Encadrement sur la frise

C'est notre quatre-vingtième jour de classe.

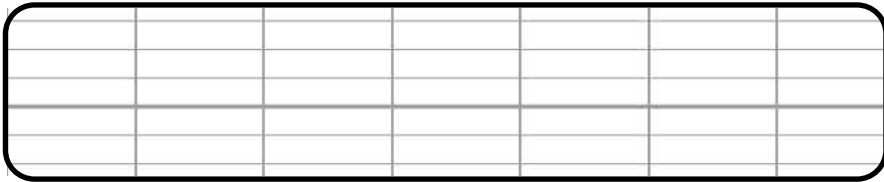

	
Dizaines	Unités

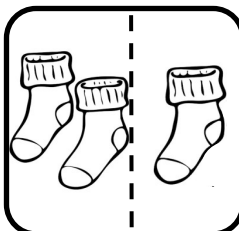

$$80 = 70 + \dots$$
$$\dots < 80 < \dots$$

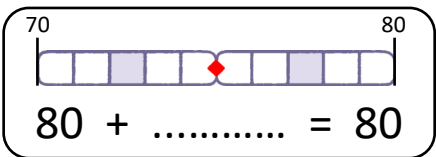
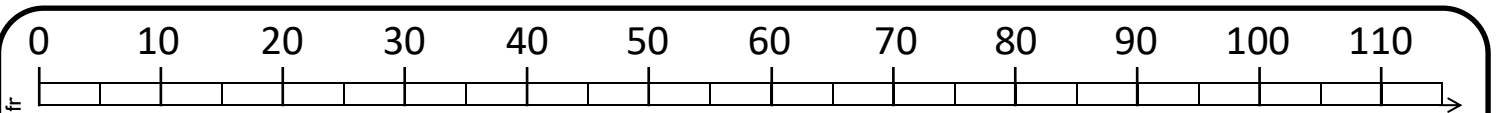
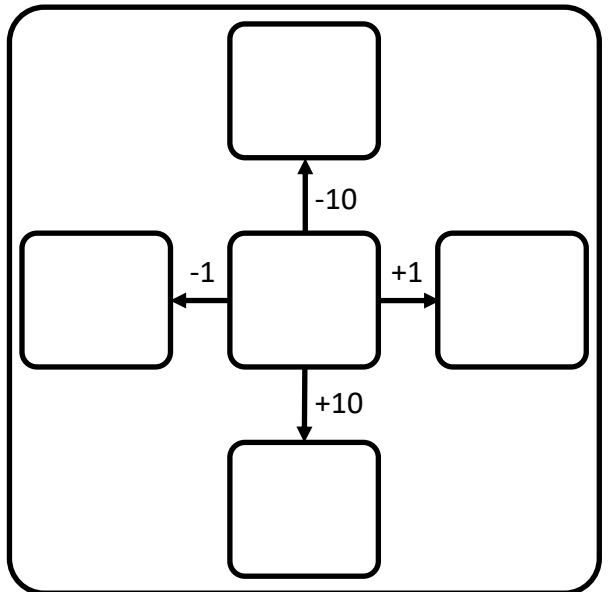

..... Encadrement sur la frise

C'est notre quatre-vingt-et-unième jour de classe.

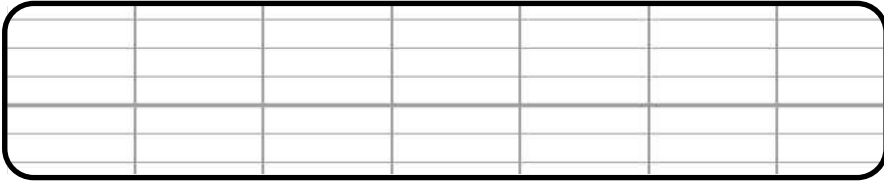

Dizaines	Unités

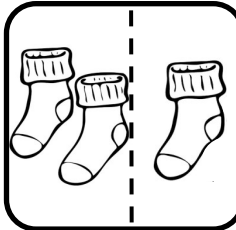

$$81 = \dots + \dots$$
$$\dots < 81 < \dots$$

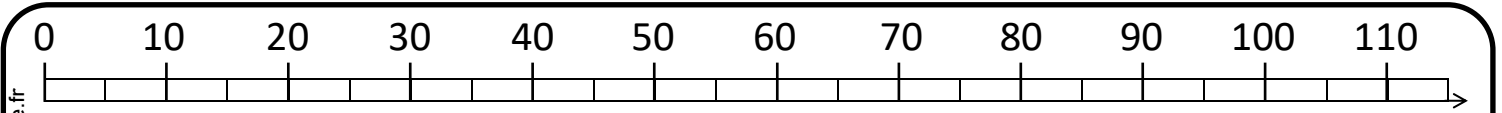
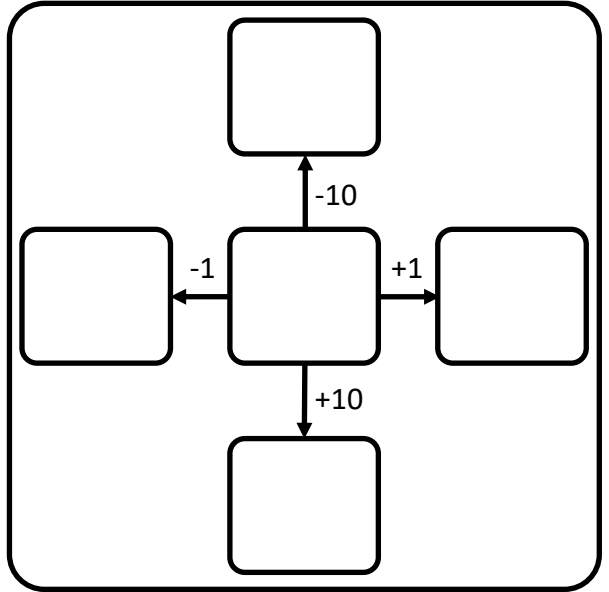

www.fabricole.fr

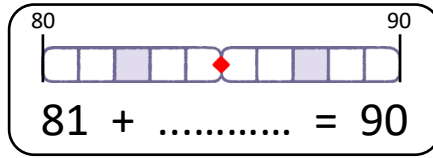

Encadrement sur la frise

C'est notre quatre-vingt-deuxième jour de classe.

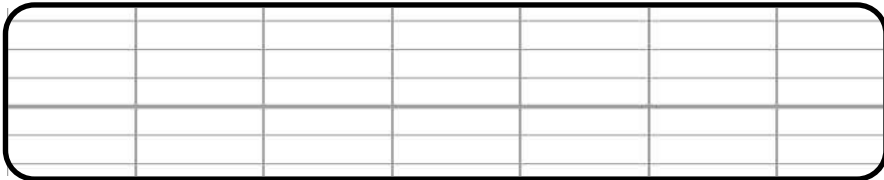

Dizaines	Unités

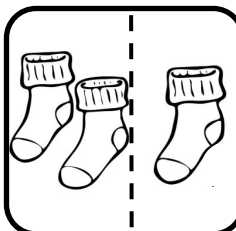

$$82 = \dots + \dots$$
$$\dots < 82 < \dots$$

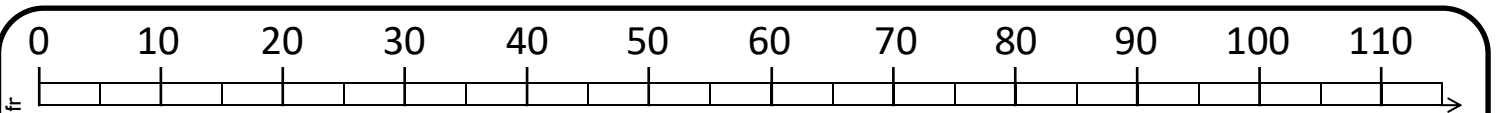
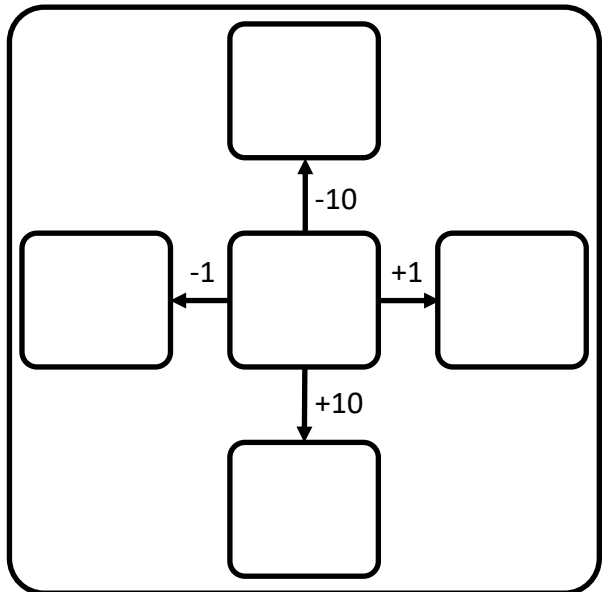

www.fabricole.fr

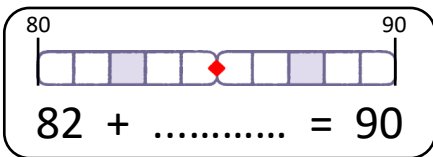

Encadrement sur la frise

C'est notre quatre-vingt-troisième jour de classe.

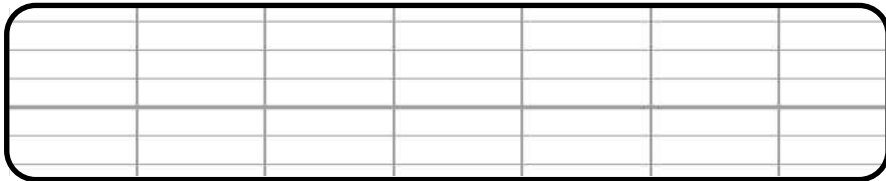

Dizaines	Unités

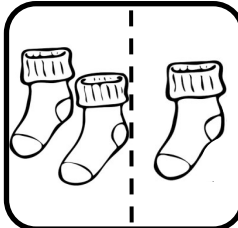

$$83 = \dots + \dots$$
$$\dots < 83 < \dots$$

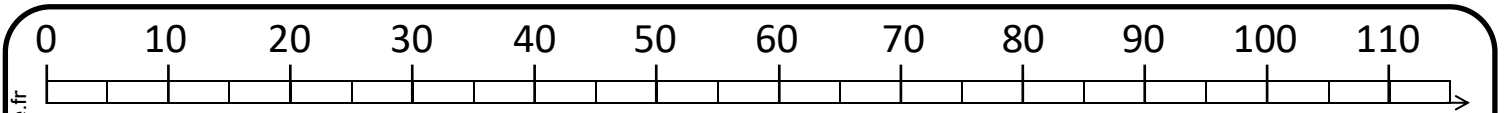
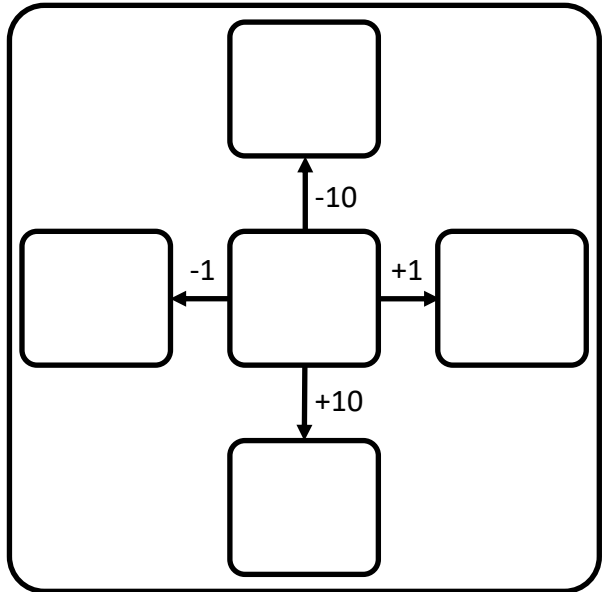

www.fabricole.fr

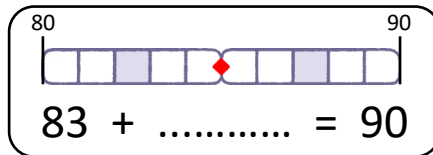

Encadrement sur la frise

C'est notre quatre-vingt-quatrième jour de classe.

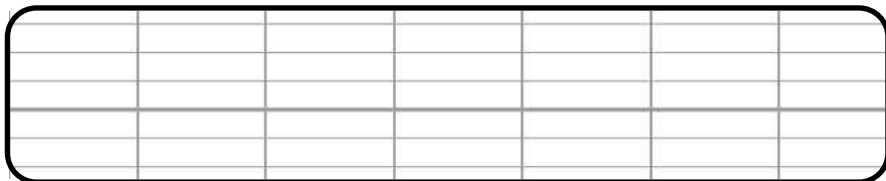

Dizaines	Unités

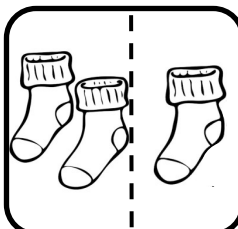

$$84 = \dots + \dots$$
$$\dots < 84 < \dots$$

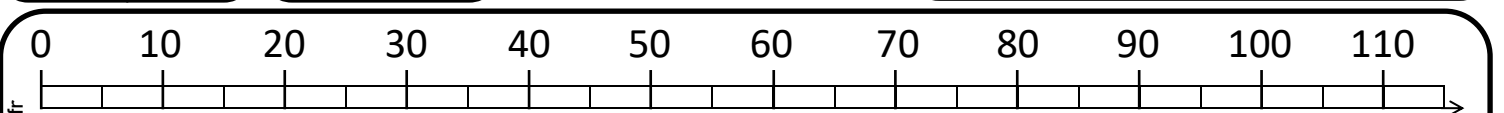
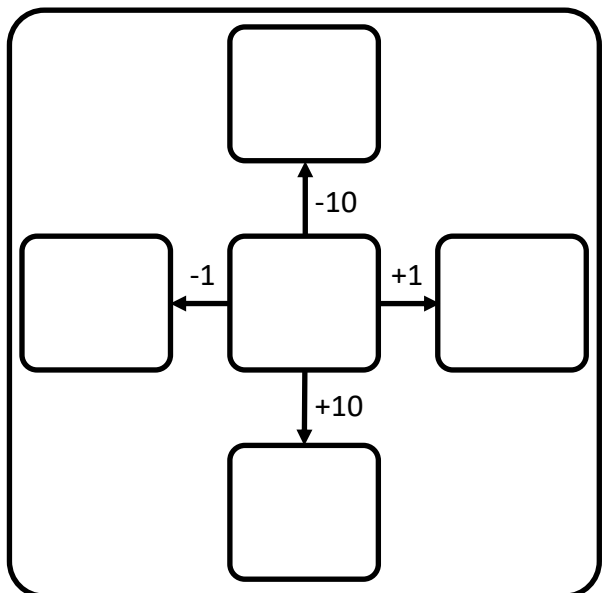

www.fabricole.fr

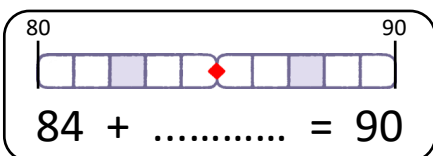

Encadrement sur la frise

C'est notre quatre-vingt-septième jour de classe.

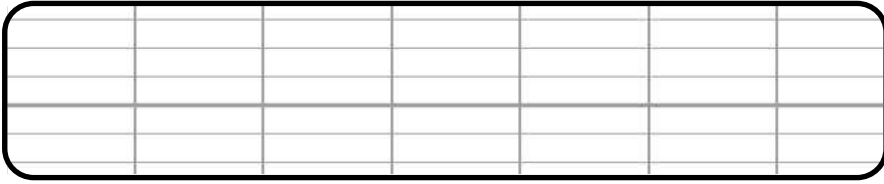

Dizaines	Unités

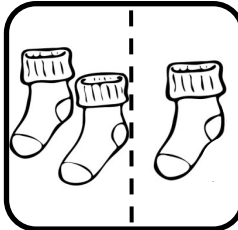

$$87 = \dots + \dots$$
$$\dots < 87 < \dots$$

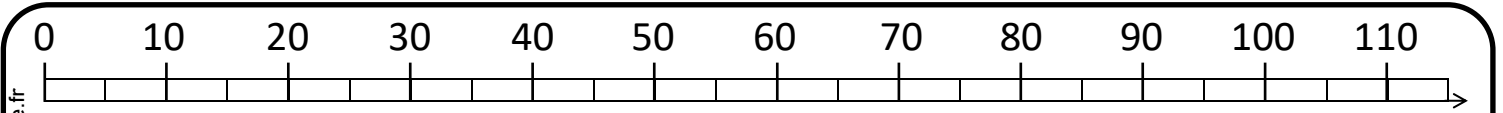
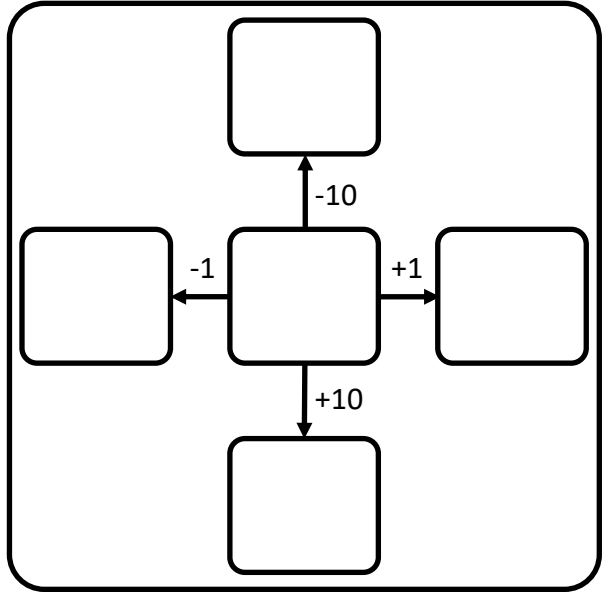

www.fabricole.fr

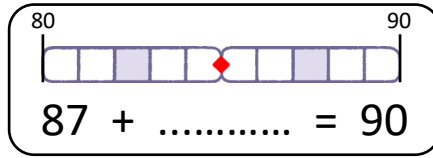

Encadrement sur la frise

C'est notre quatre-vingt-huitième jour de classe.

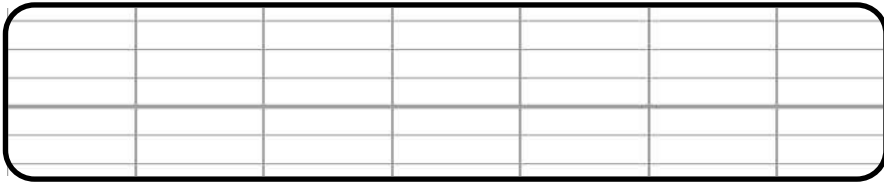

Dizaines	Unités

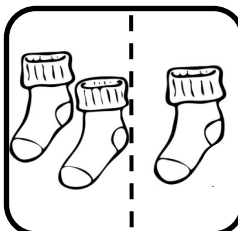

$$88 = \dots + \dots$$
$$\dots < 88 < \dots$$

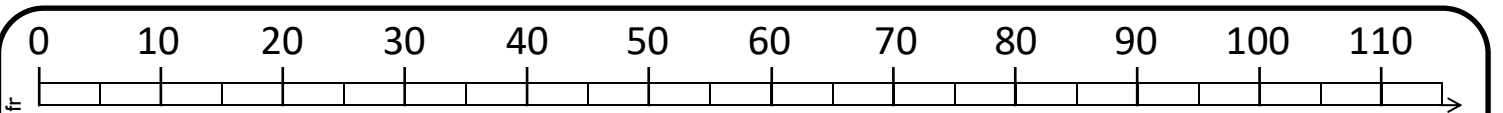
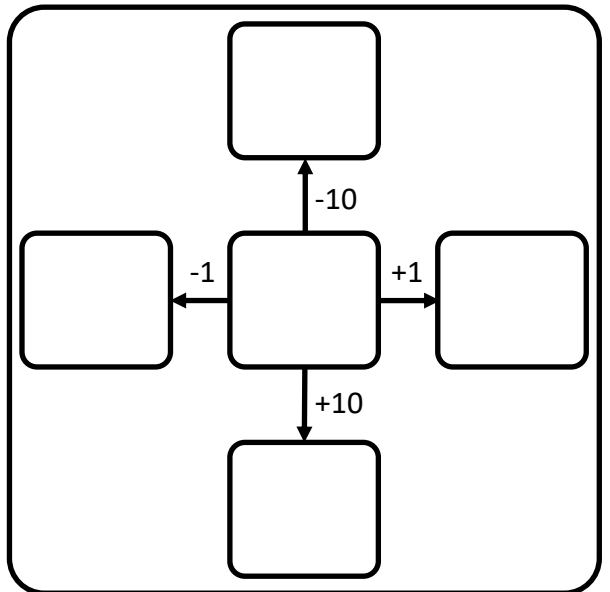

www.fabricole.fr

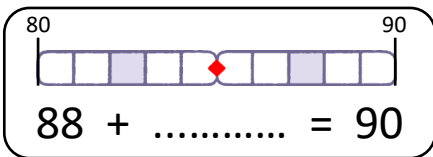

Encadrement sur la frise

C'est notre quatre-vingt-onzième jour de classe.

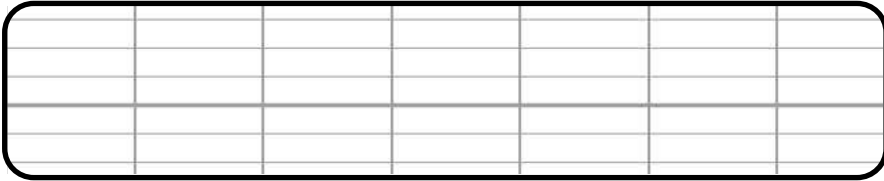

Dizaines	Unités

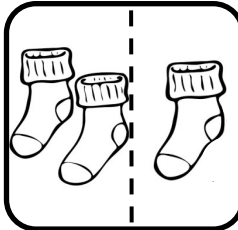

$$91 = \dots + \dots$$
$$\dots < 91 < \dots$$

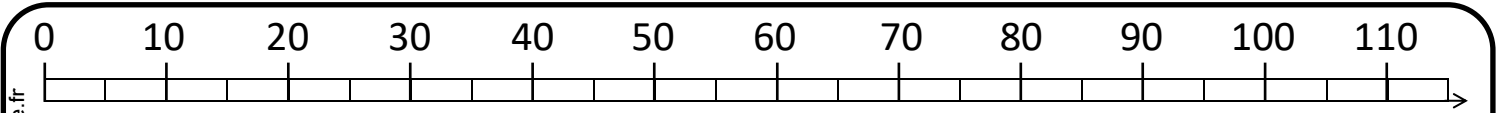
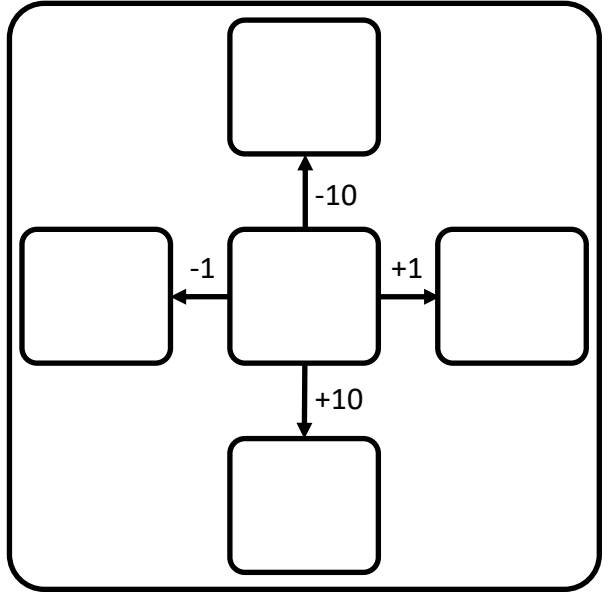

www.fabricole.fr

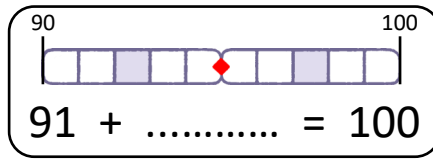

Encadrement sur la frise

C'est notre quatre-vingt-douzième jour de classe.

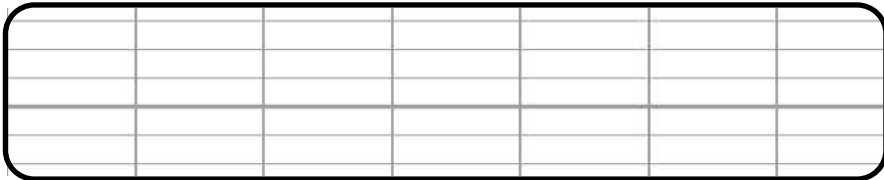

Dizaines	Unités

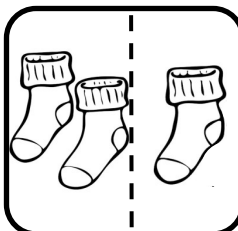

$$92 = \dots + \dots$$
$$\dots < 92 < \dots$$

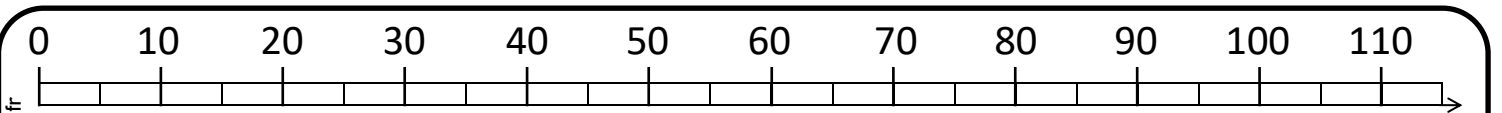
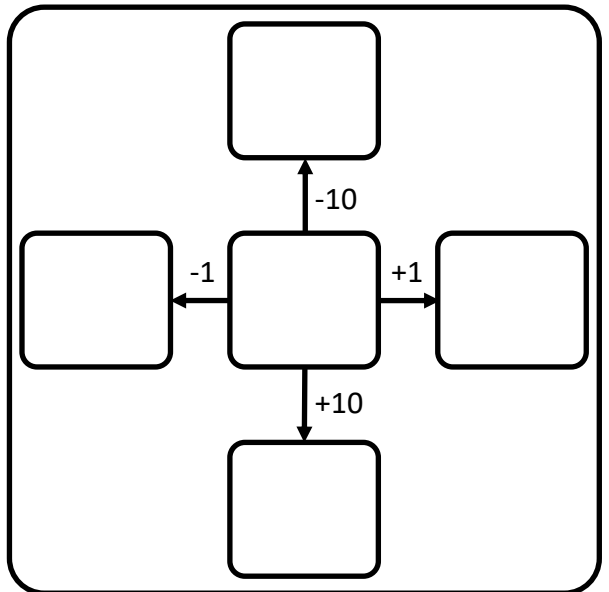

www.fabricole.fr

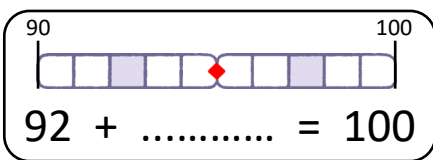

Encadrement sur la frise

C'est notre quatre-vingt-treizième jour de classe.

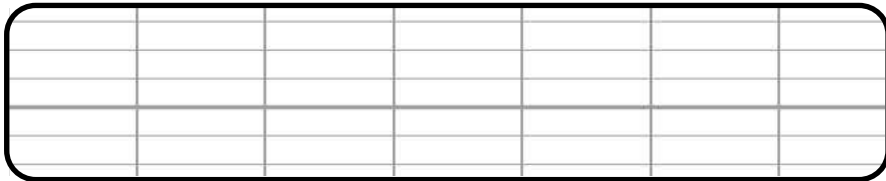

Dizaines	Unités

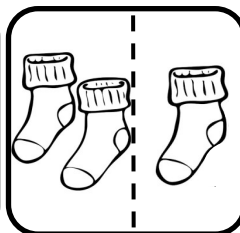

$$93 = \dots + \dots$$
$$\dots < 93 < \dots$$

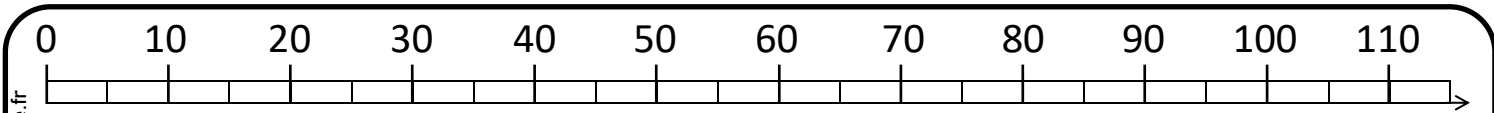
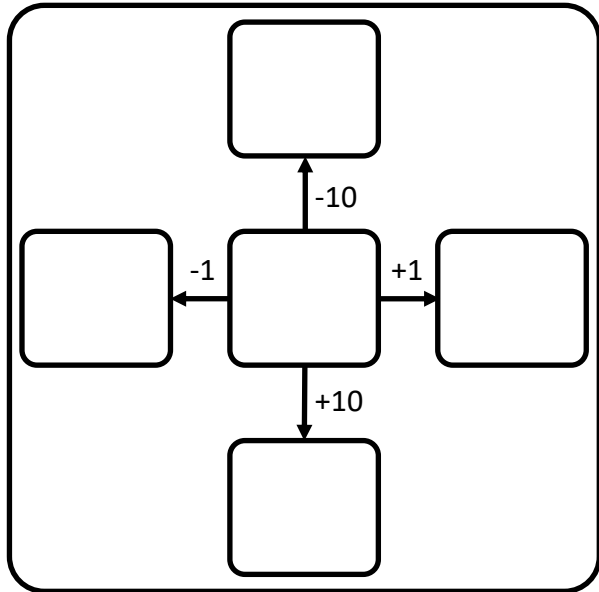

www.fabricole.fr

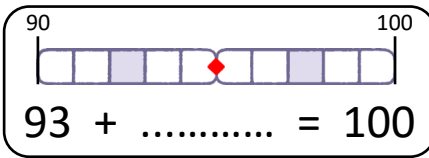

Encadrement sur la frise

C'est notre quatre-vingt-quatorzième jour de classe.

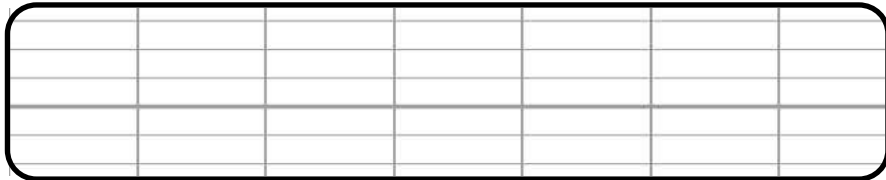

Dizaines	Unités

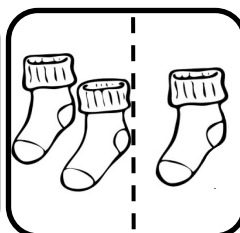

$$94 = \dots + \dots$$
$$\dots < 94 < \dots$$

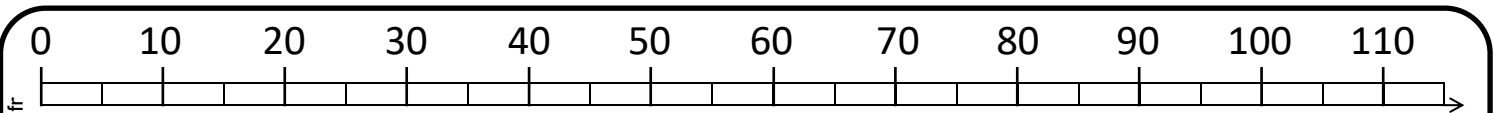
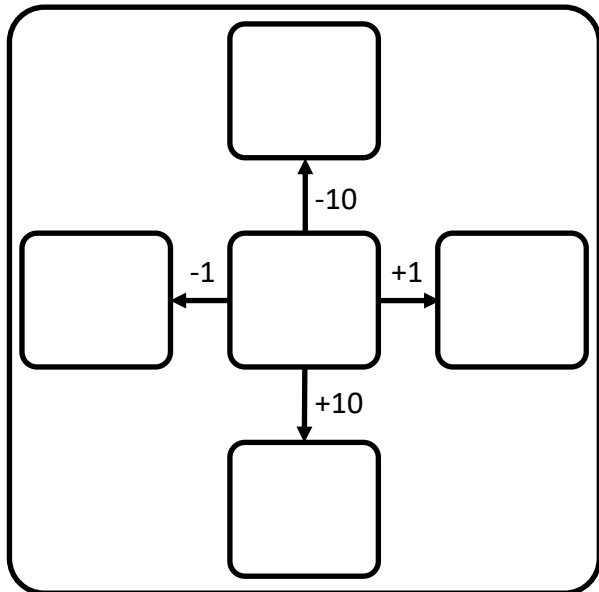

www.fabricole.fr

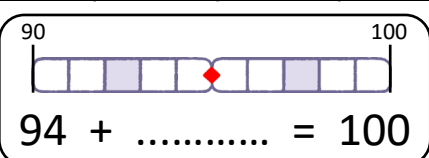

Encadrement sur la frise

C'est notre quatre-vingt-quinzième jour de classe.

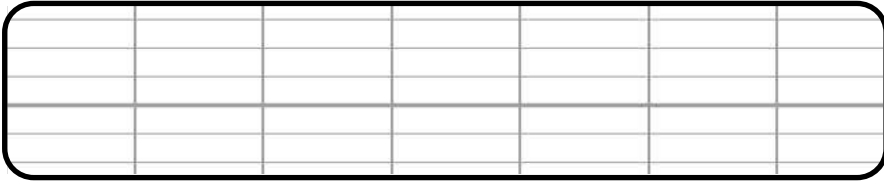

Dizaines	Unités

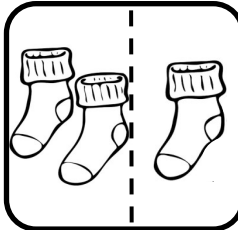

$$95 = \dots + \dots$$
$$\dots < 95 < \dots$$

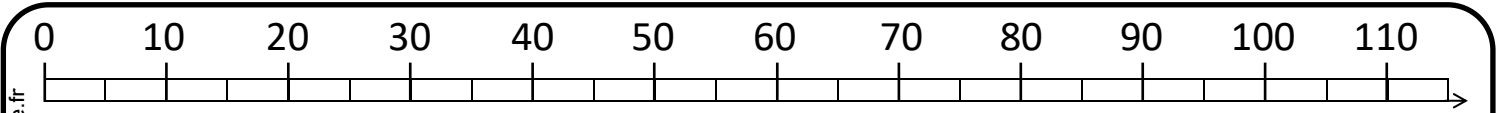
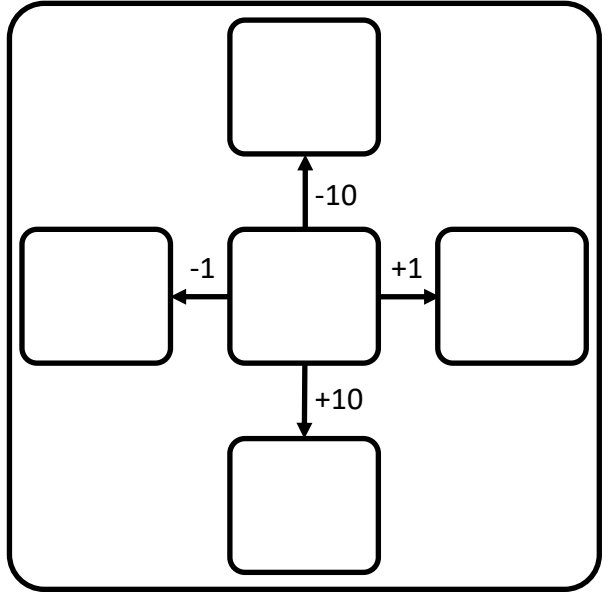

www.fabricole.fr

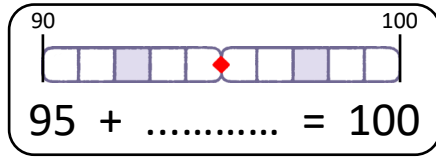

Encadrement sur la frise

C'est notre quatre-vingt-seizième jour de classe.

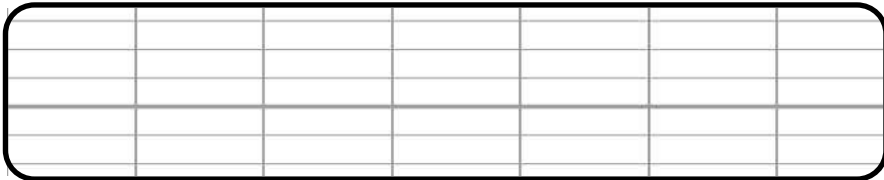

Dizaines	Unités

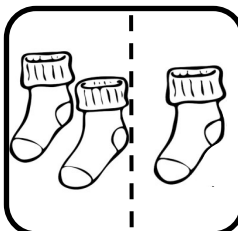

$$96 = \dots + \dots$$
$$\dots < 96 < \dots$$

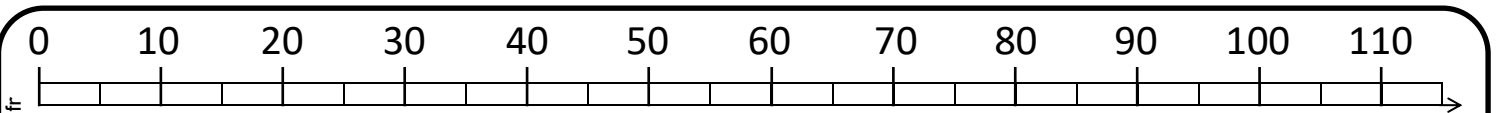
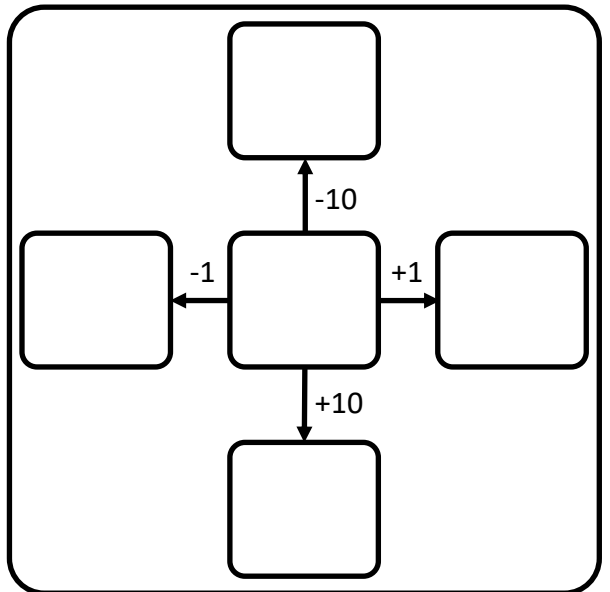

www.fabricole.fr

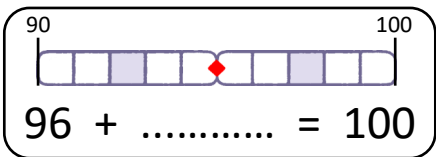

Encadrement sur la frise

C'est notre quatre-vingt-dix-septième jour de classe.

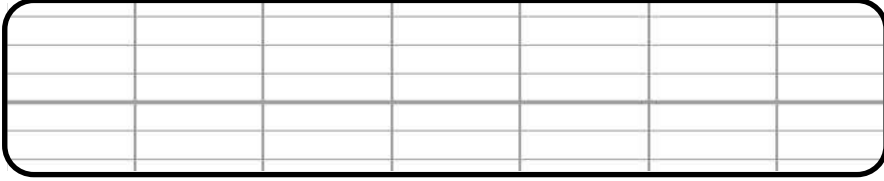

Dizaines	Unités

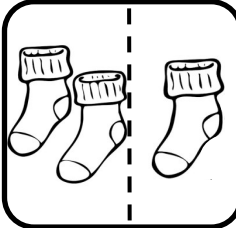

$$97 = \dots + \dots$$
$$\dots < 97 < \dots$$

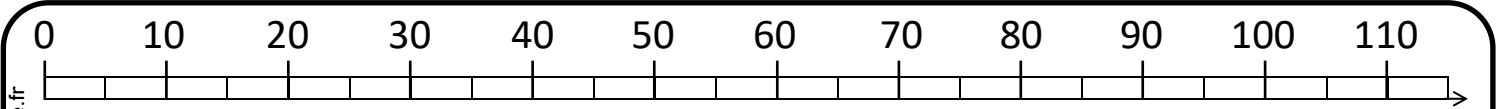
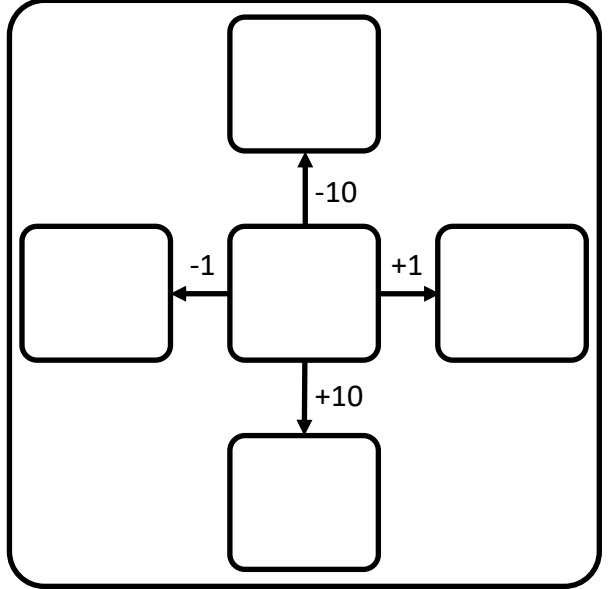

www.fabricole.fr

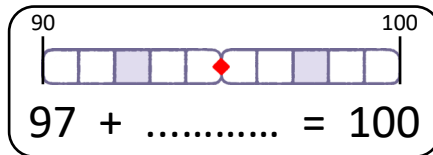

Encadrement sur la frise

C'est notre quatre-vingt-dix-huitième jour de classe.

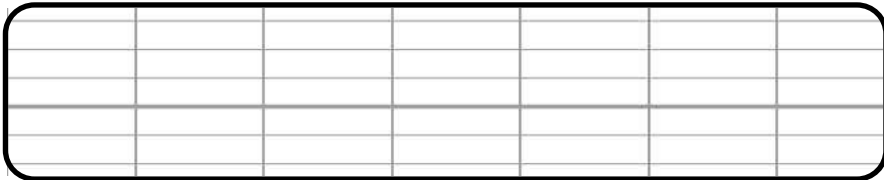

Dizaines	Unités

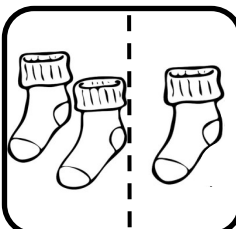

$$98 = \dots + \dots$$
$$\dots < 98 < \dots$$

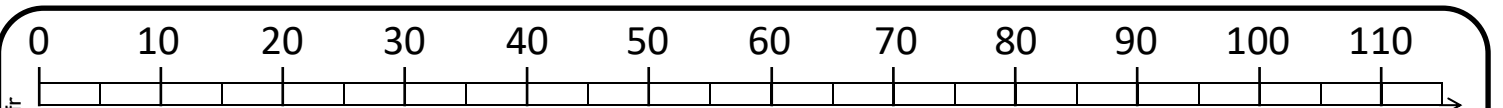
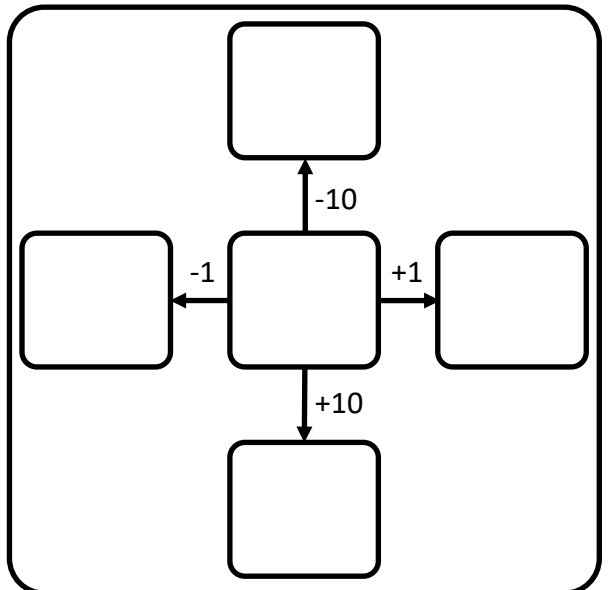

www.fabricole.fr

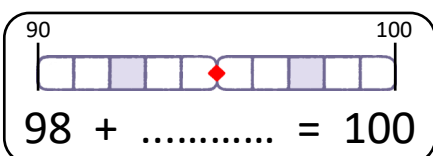

Encadrement sur la frise

C'est notre quatre-vingt-dix-neuvième jour de classe.

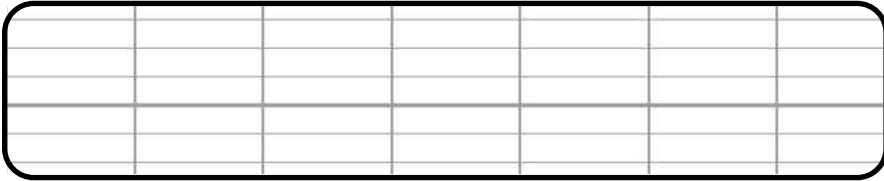

Dizaines	Unités

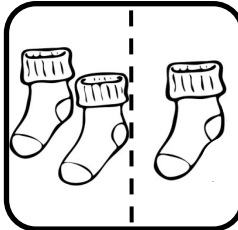

$$99 = \dots + \dots$$

$$\dots < 99 < \dots$$

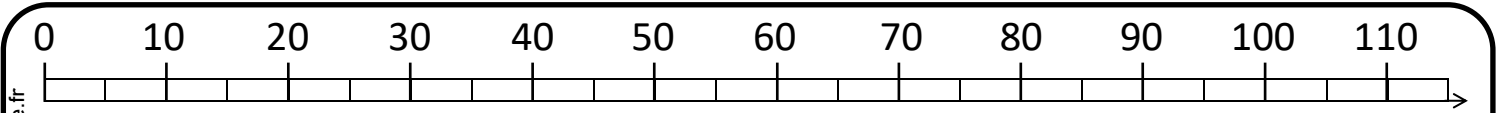
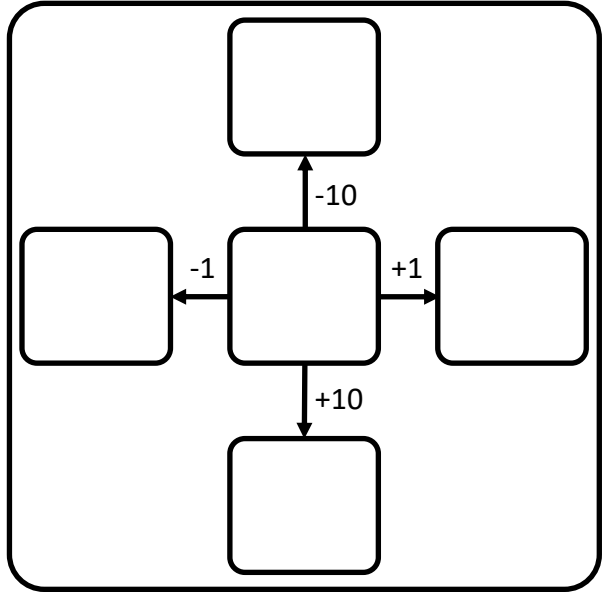

www.fabricole.fr

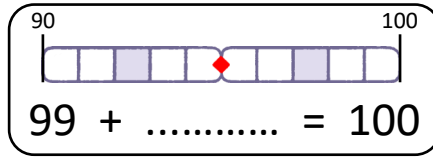

Encadrement sur la frise

$$99 + \dots = 100$$

C'est notre centième jour de classe !!!

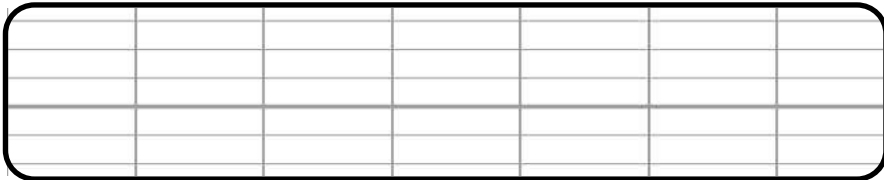

Dizaines	Unités



$$100 = \dots + \dots$$

$$\dots < 100 < \dots$$

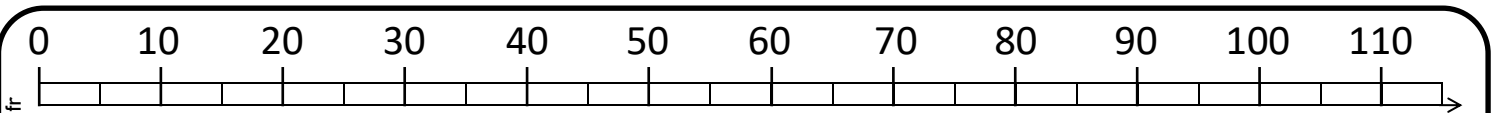
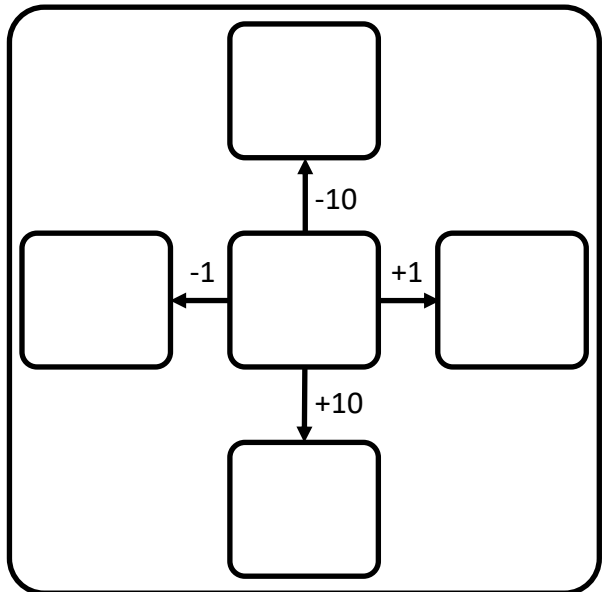

www.fabricole.fr

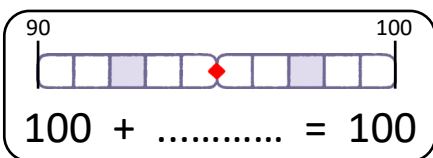

Encadrement sur la frise

$$100 + \dots = 100$$

C'est notre cent-unième jour de classe.

101 .

$$101 = \dots + \dots$$



Centaine



Dizaines



Unités

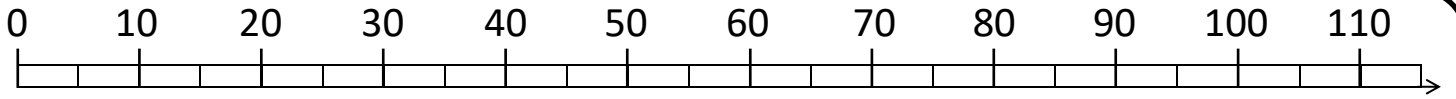
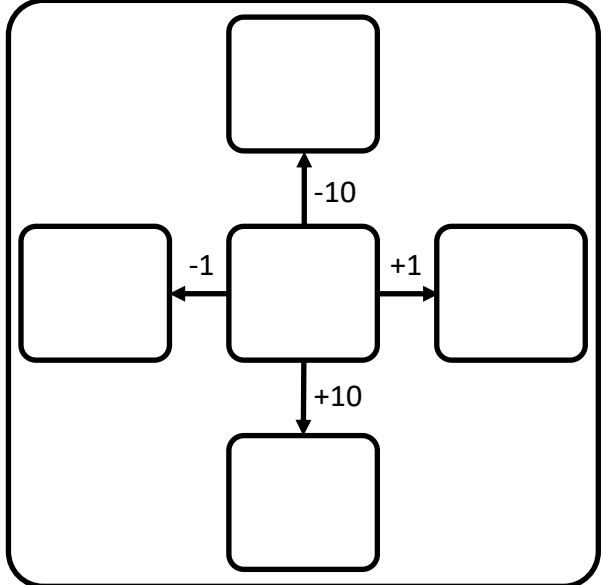
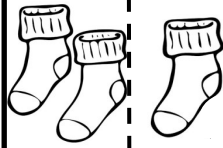

www.fabricole.fr

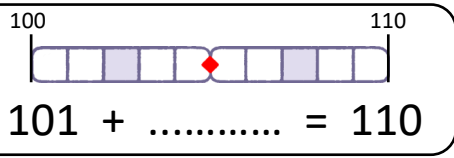

Encadrement sur la frise

.....

C'est notre cent-deuxième jour de classe.

102 .

$$102 = \dots + \dots$$



Centaine



Dizaines



Unités

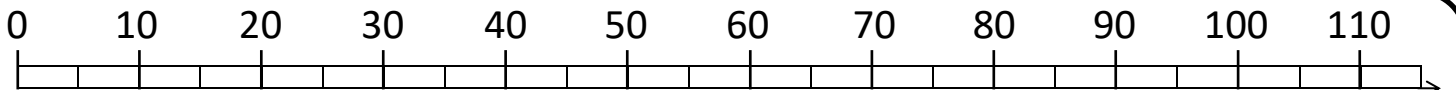
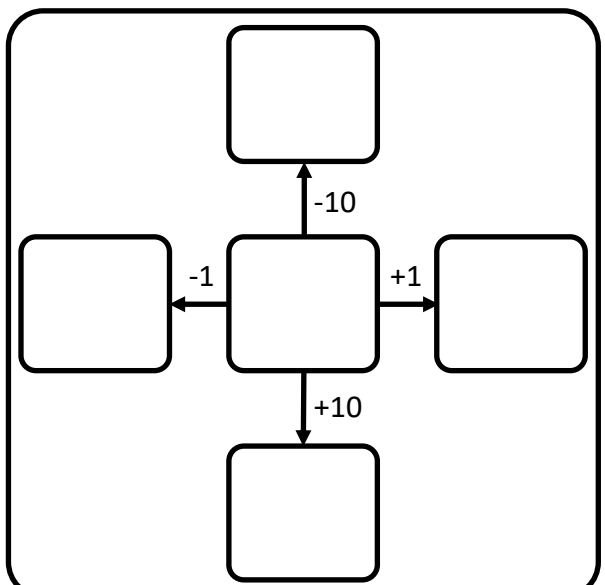
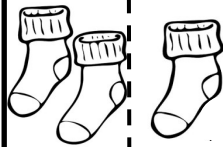

www.fabricole.fr

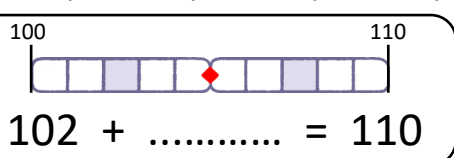

Encadrement sur la frise

.....

C'est notre cent-troisième jour de classe.

103 .

$$103 = \dots + \dots$$



Centaine



Dizaines



Unités

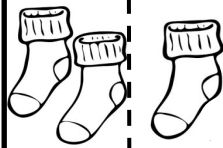

-10

-1

+1

+10



www.fabricole.fr



$$103 + \dots = 110$$

Encadrement sur la frise

C'est notre cent-quatrième jour de classe.

104 .

$$104 = \dots + \dots$$



Centaine



Dizaines



Unités

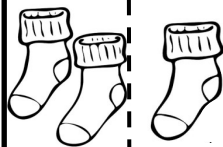

-10

-1

+1

+10



www.fabricole.fr

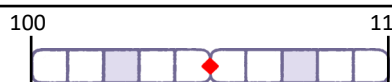

$$104 + \dots = 110$$

Encadrement sur la frise

C'est notre cent-cinquième jour de classe.

105 .

$$105 = \dots + \dots$$



Centaine Dizaines Unités

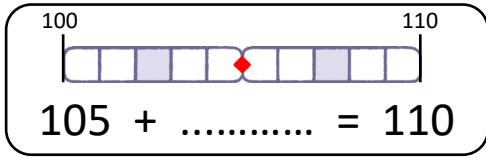
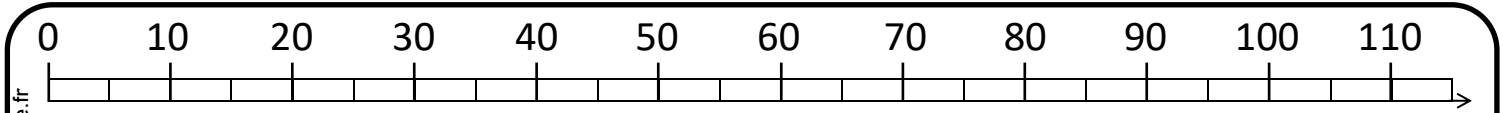
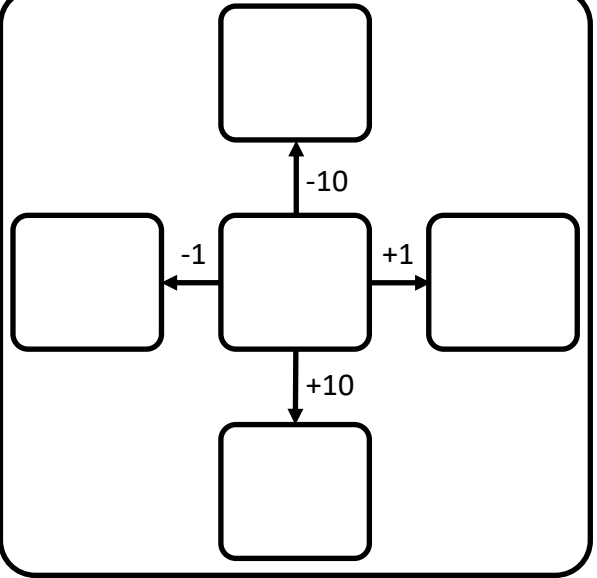
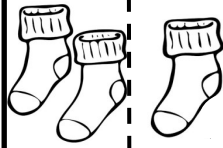

Encadrement sur la frise

C'est notre cent-sixième jour de classe.

106 .

$$106 = \dots + \dots$$



Centaine Dizaines Unités

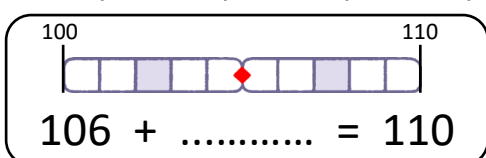
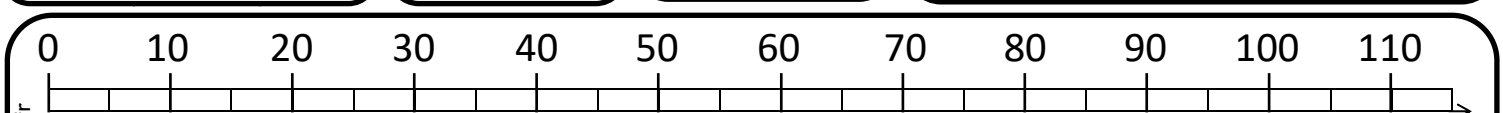
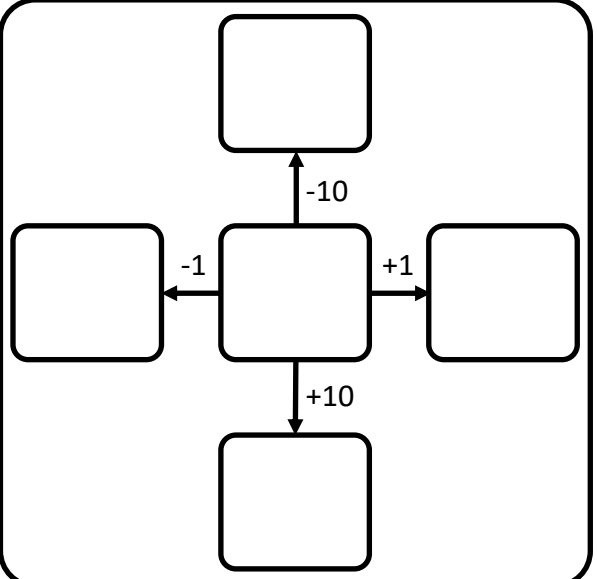

Encadrement sur la frise

C'est notre cent-septième jour de classe.

107 .

$$107 = \dots + \dots$$



Centaine



Dizaines



Unités

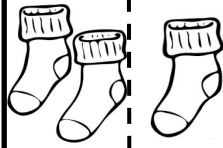

-10

-1

+1

+10

0 10 20 30 40 50 60 70 80 90 100 110

www.fabricole.fr



$$107 + \dots = 110$$

Encadrement sur la frise

C'est notre cent-huitième jour de classe.

108 .

$$108 = \dots + \dots$$



Centaine



Dizaines



Unités

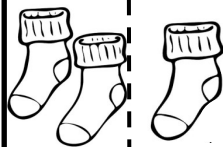

-10

-1

+1

+10

0 10 20 30 40 50 60 70 80 90 100 110

www.fabricole.fr



$$108 + \dots = 110$$

Encadrement sur la frise

C'est notre cent-neuvième jour de classe.

109 .

$$109 = \dots + \dots$$



Centaine Dizaines Unités

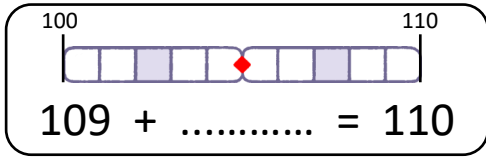
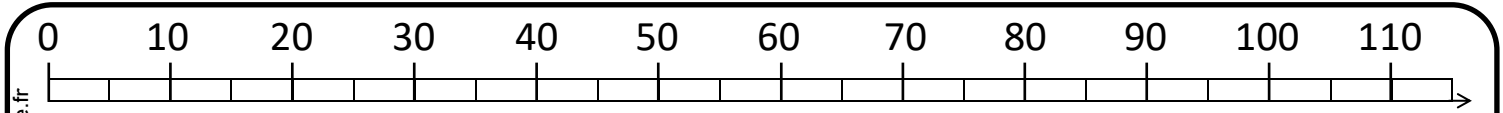
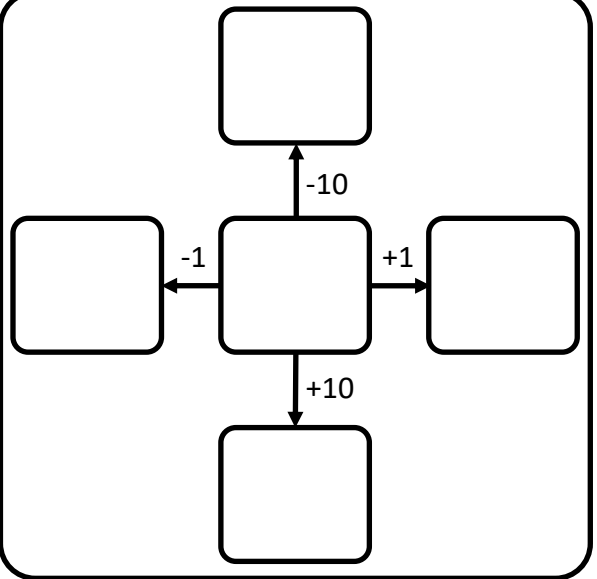
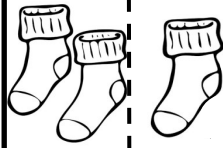

Encadrement sur la frise

C'est notre cent-dixième jour de classe.

110 .

$$110 = \dots + \dots$$



Centaine Dizaines Unités

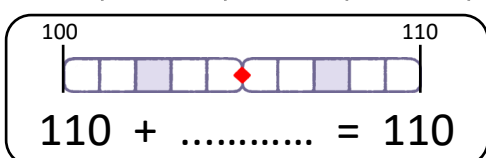
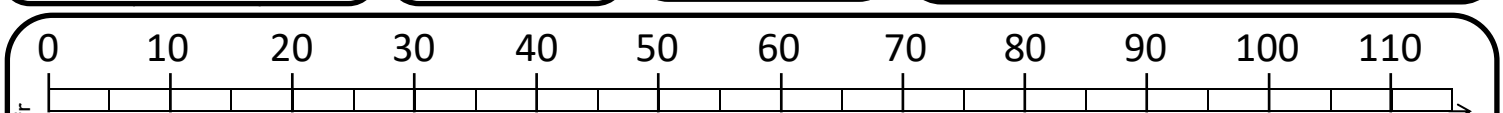
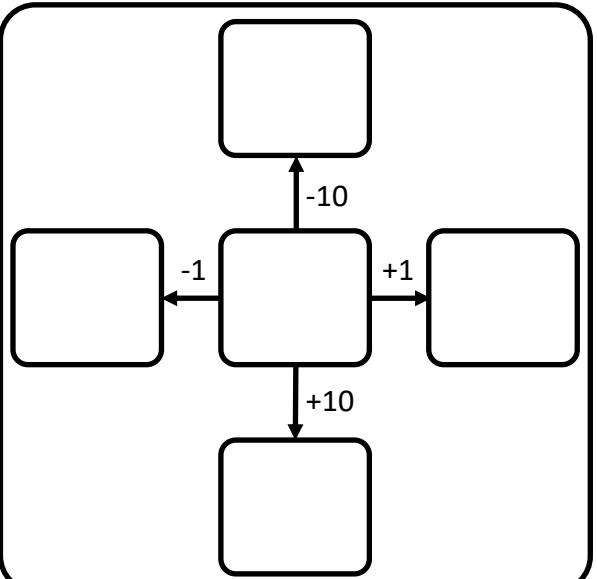

Encadrement sur la frise

C'est notre cent-onzième jour de classe.

111 .

$$111 = 100 + 10 + \dots\dots$$



Centaine



Dizaines



Unités

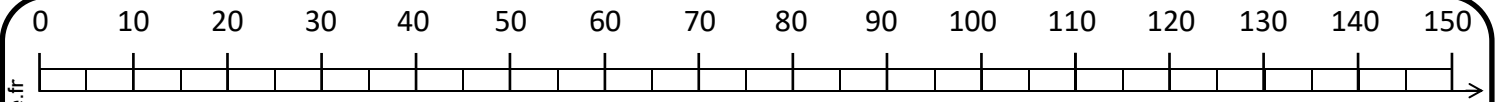
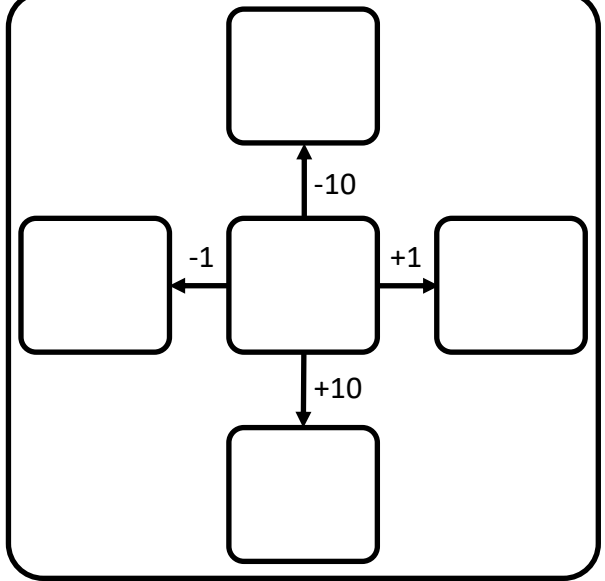
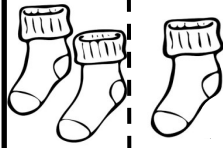

www.fabricole.fr

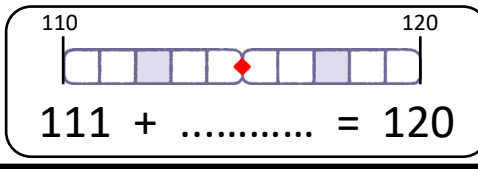

Encadrement sur la frise

.....

C'est notre cent-douzième jour de classe.

112 .

$$112 = \dots\dots + \dots\dots + \dots\dots$$



Centaine



Dizaines



Unités

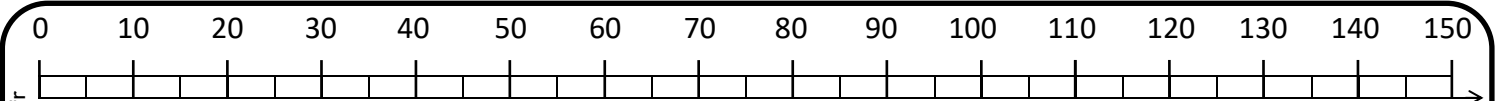
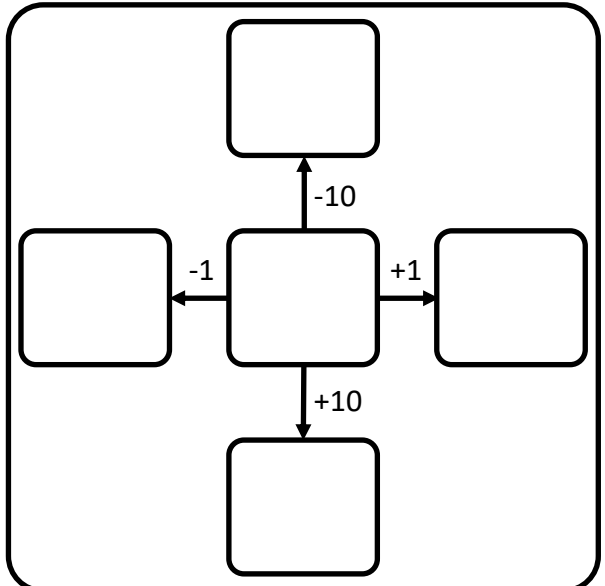
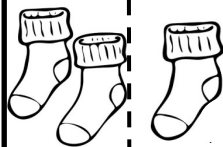

www.fabricole.fr

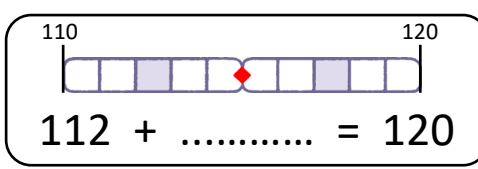

Encadrement sur la frise

.....

C'est notre cent-treizième jour de classe.

113 .

$$113 = \dots + \dots + \dots$$



Centaine Dizaines Unités

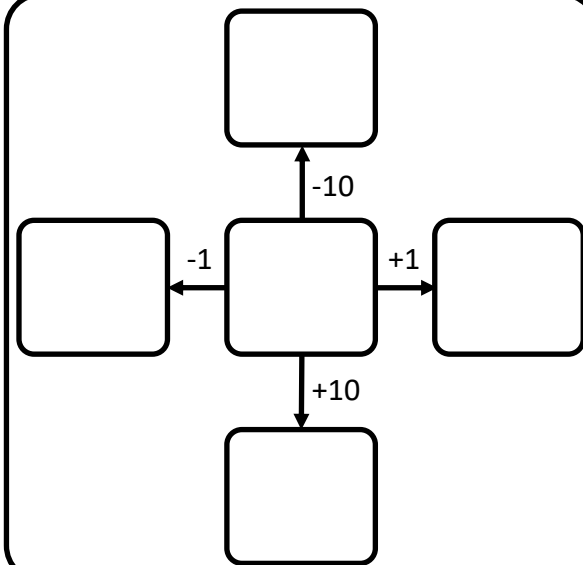

0 10 20 30 40 50 60 70 80 90 100 110 120 130 140 150

www.fabricole.fr

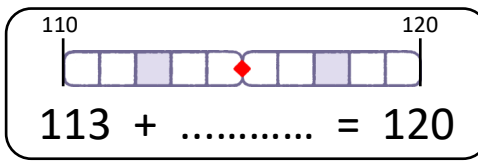

Encadrement sur la frise

.....

C'est notre cent-quatorzième jour de classe.

114 .

$$114 = \dots + \dots + \dots$$



Centaine Dizaines Unités

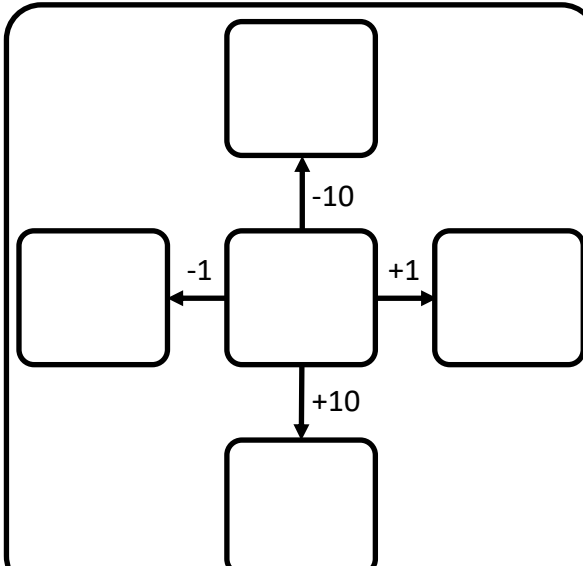

0 10 20 30 40 50 60 70 80 90 100 110 120 130 140 150

www.fabricole.fr

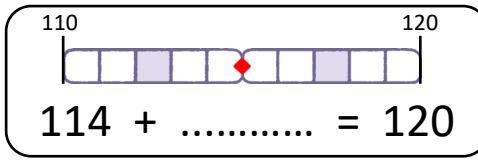

Encadrement sur la frise

.....

C'est notre cent-quinzième jour de classe.

115 .

$$115 = \dots + \dots + \dots$$



Centaine Dizaines Unités

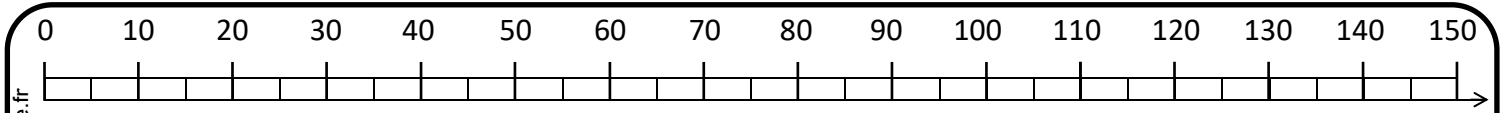
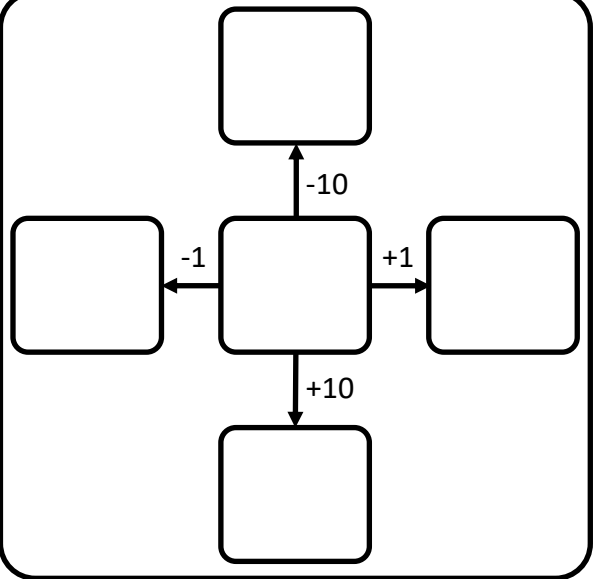
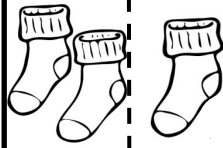

www.fabricole.fr

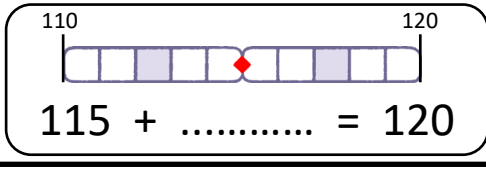

Encadrement sur la frise

C'est notre cent-seizième jour de classe.

116 .

$$116 = \dots + \dots + \dots$$



Centaine Dizaines Unités

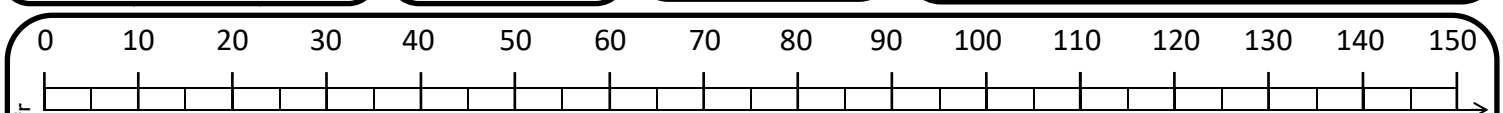
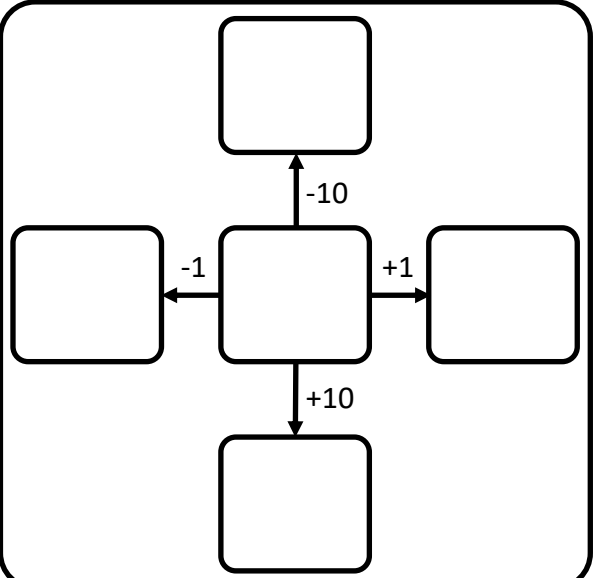

www.fabricole.fr

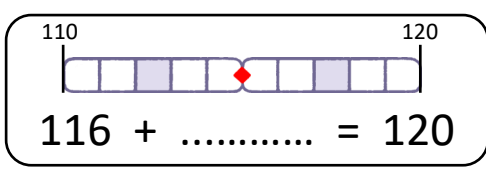

Encadrement sur la frise

C'est notre cent-dix-septième jour de classe.

117 .

$$117 = \dots + \dots + \dots$$



Centaine Dizaines Unités

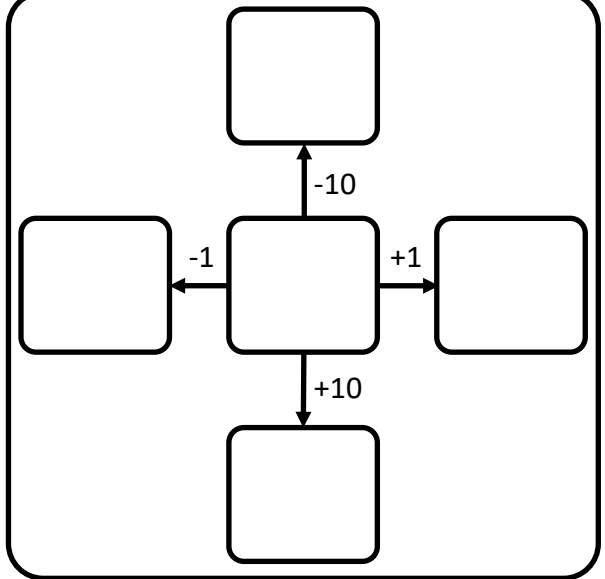
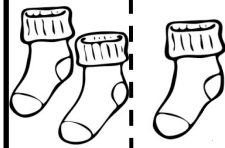

0 10 20 30 40 50 60 70 80 90 100 110 120 130 140 150

www.fabricole.fr

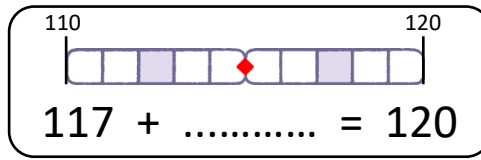

Encadrement sur la frise

C'est notre cent-dix-huitième jour de classe.

118 .

$$118 = \dots + \dots + \dots$$



Centaine Dizaines Unités

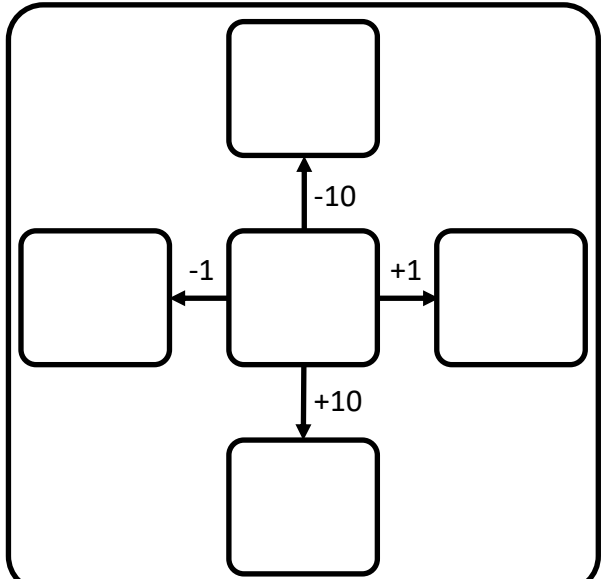
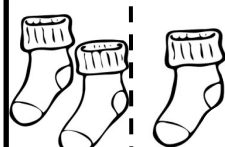

0 10 20 30 40 50 60 70 80 90 100 110 120 130 140 150

www.fabricole.fr

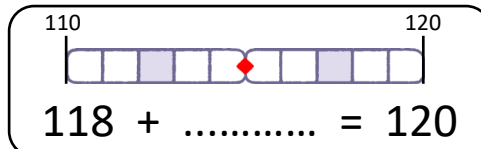

Encadrement sur la frise

C'est notre cent-dix-neuvième jour de classe.

119 .

$$119 = \dots + \dots + \dots$$



Centaine Dizaines Unités

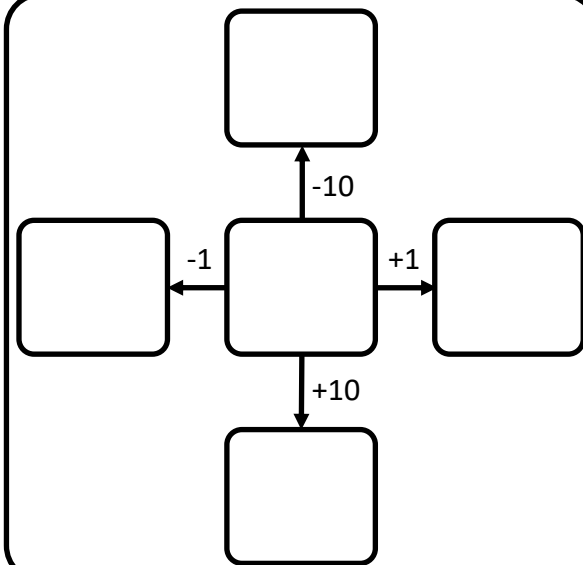
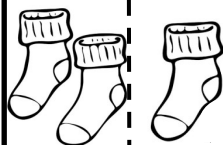

0 10 20 30 40 50 60 70 80 90 100 110 120 130 140 150

www.fabricole.fr

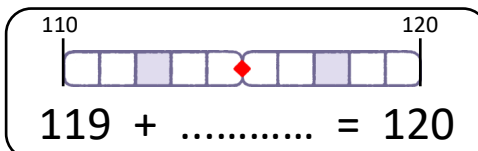

Encadrement sur la frise

.....

C'est notre cent-vingtième jour de classe.

120 .

$$120 = \dots + \dots$$



Centaine Dizaines Unités

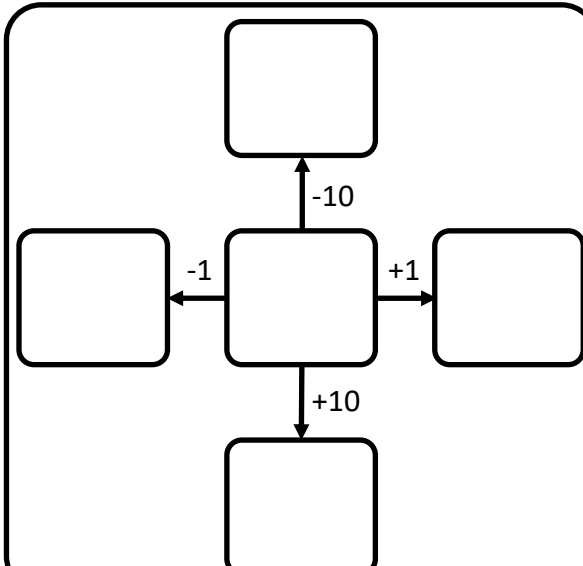
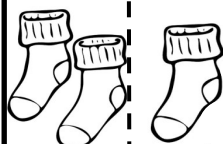

0 10 20 30 40 50 60 70 80 90 100 110 120 130 140 150

www.fabricole.fr

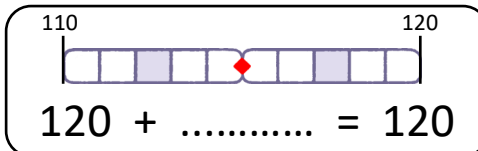

Encadrement sur la frise

.....

C'est notre cent-vingt-et-unième jour de classe.

121 .

$$121 = \dots + \dots + \dots$$



Centaine Dizaines Unités

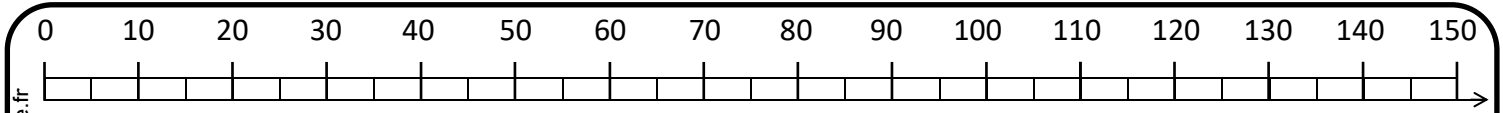
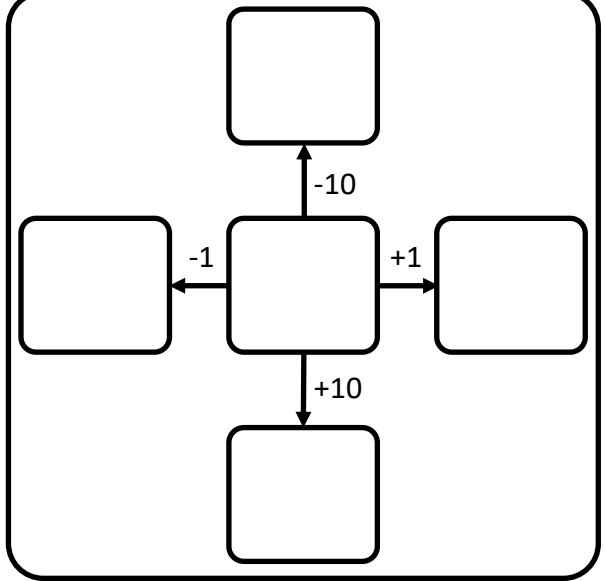
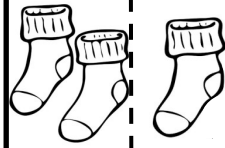

www.fabricole.fr

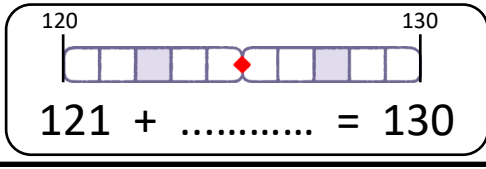

Encadrement sur la frise

.....

C'est notre cent-vingt-deuxième jour de classe.

122 .

$$122 = \dots + \dots + \dots$$



Centaine Dizaines Unités

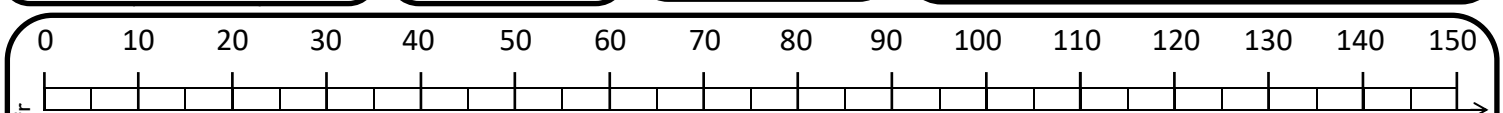
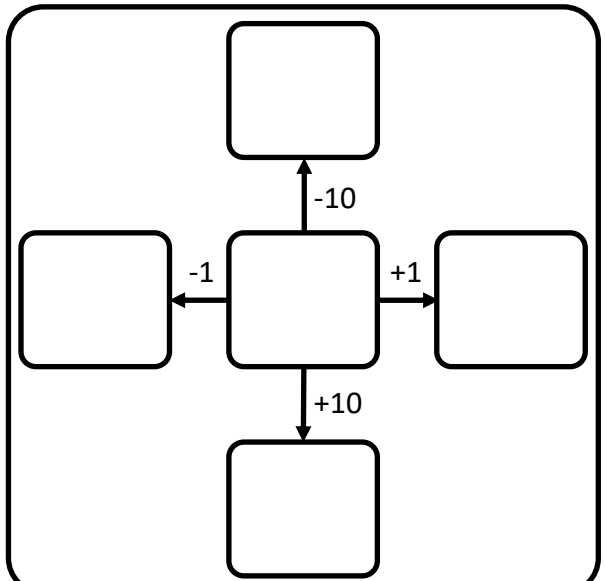
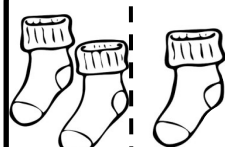

www.fabricole.fr

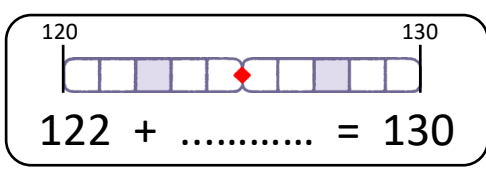

Encadrement sur la frise

.....

C'est notre cent-vingt-troisième jour de classe.

123 .

$$123 = \dots + \dots + \dots$$



Centaine Dizaines Unités

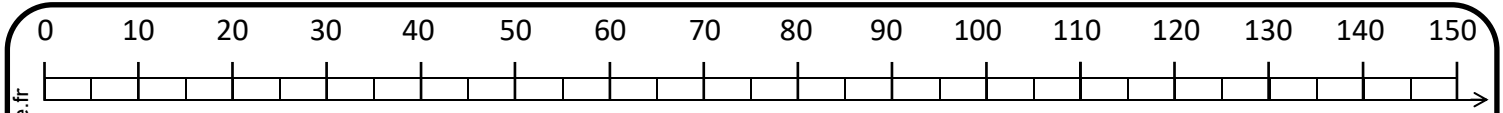
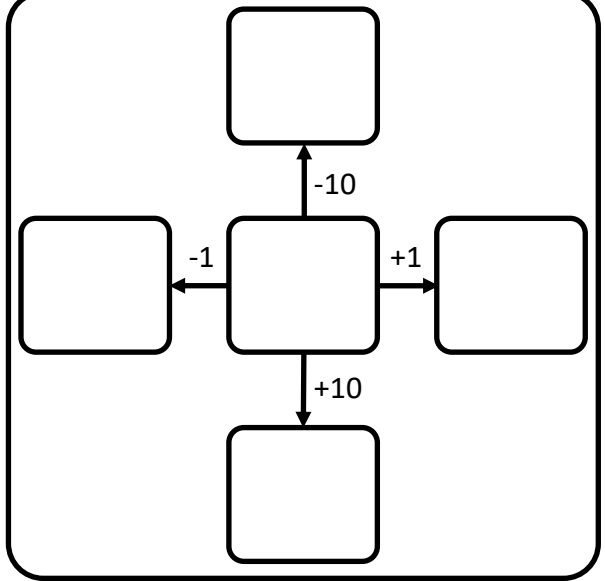
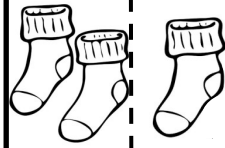

www.fabricole.fr

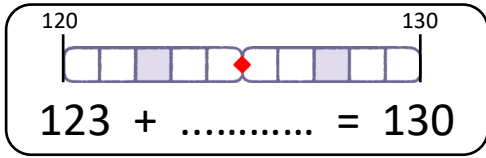

Encadrement sur la frise

.....

C'est notre cent-vingt-quatrième jour de classe.

124 .

$$124 = \dots + \dots + \dots$$



Centaine Dizaines Unités

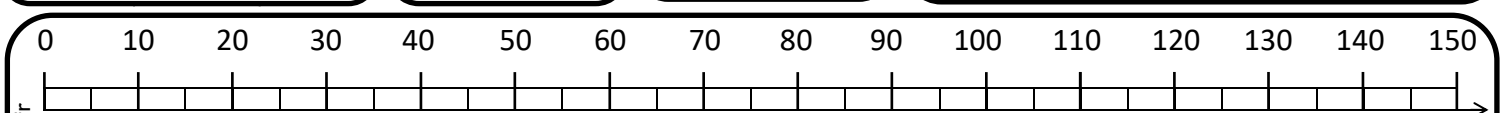
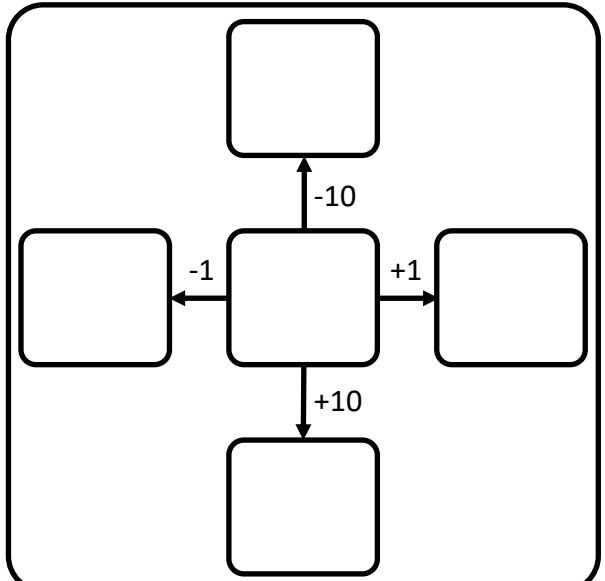
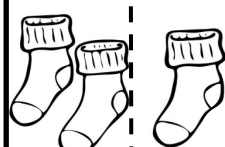

www.fabricole.fr

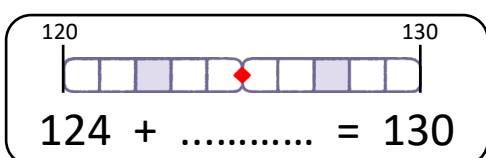

Encadrement sur la frise

.....

C'est notre cent-vingt-cinquième jour de classe.

125 .

$$125 = \dots + \dots + \dots$$



Centaine Dizaines Unités

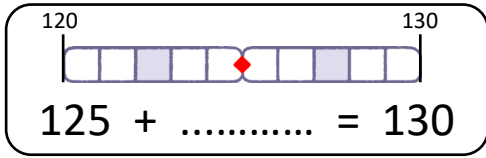
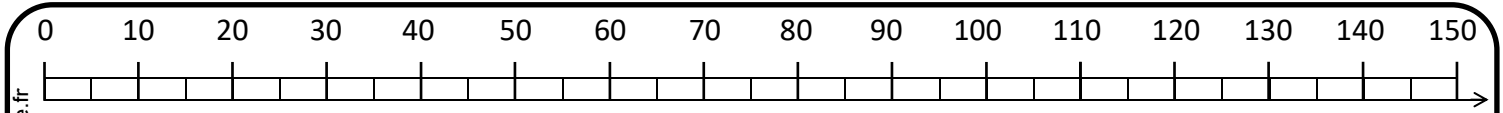
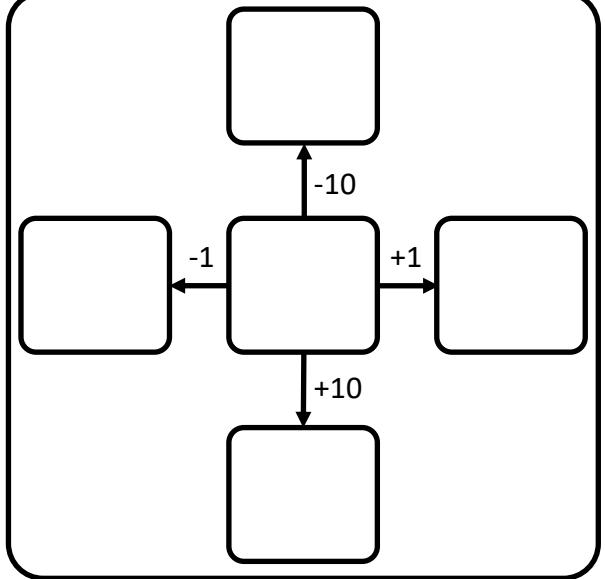
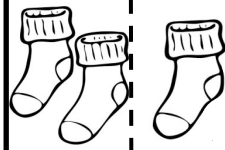

Encadrement sur la frise

C'est notre cent-vingt-sixième jour de classe.

126 .

$$126 = \dots + \dots + \dots$$



Centaine Dizaines Unités

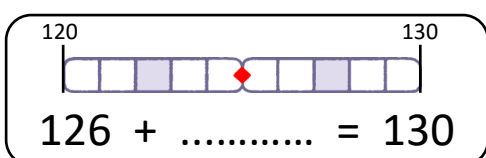
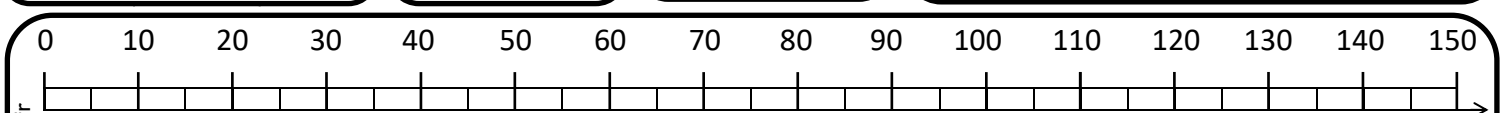
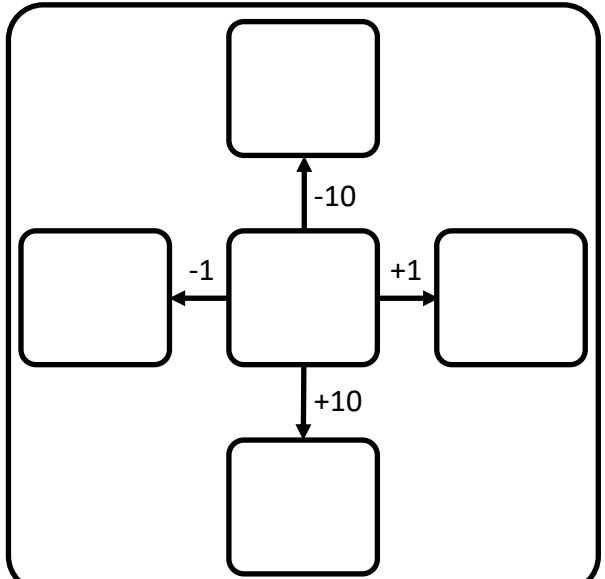
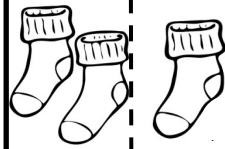

Encadrement sur la frise

C'est notre cent-vingt-septième jour de classe.

127 .

$$127 = \dots + \dots + \dots$$



Centaine Dizaines Unités

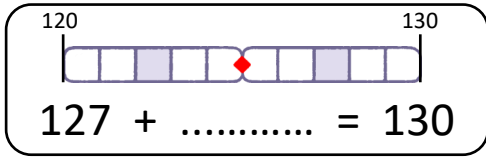
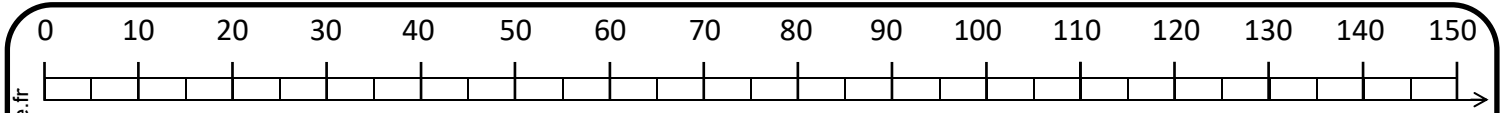
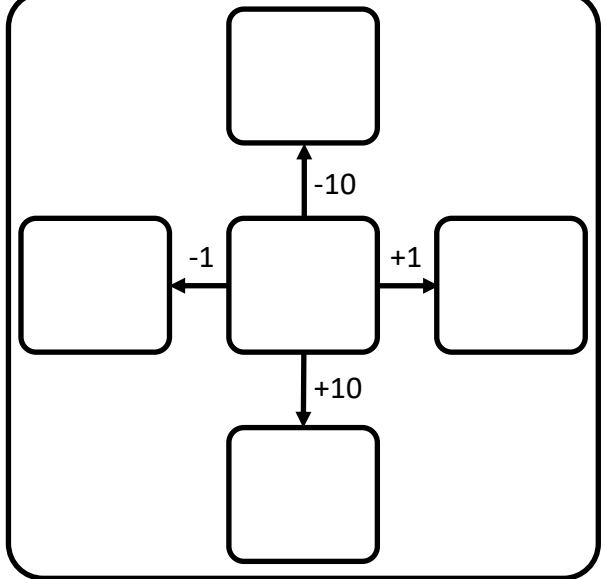
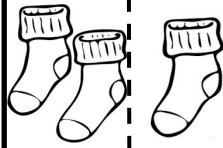

Encadrement sur la frise

C'est notre cent-vingt-huitième jour de classe.

128 .

$$128 = \dots + \dots + \dots$$



Centaine Dizaines Unités

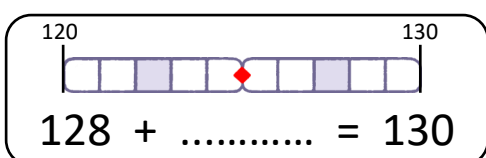
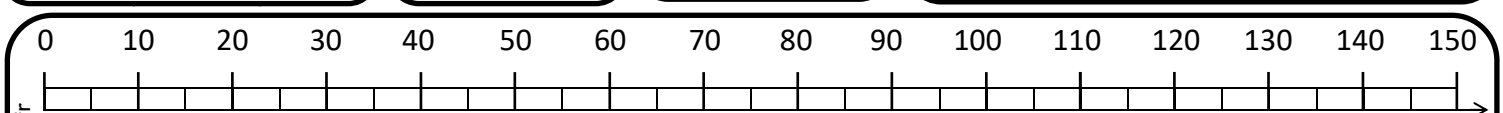
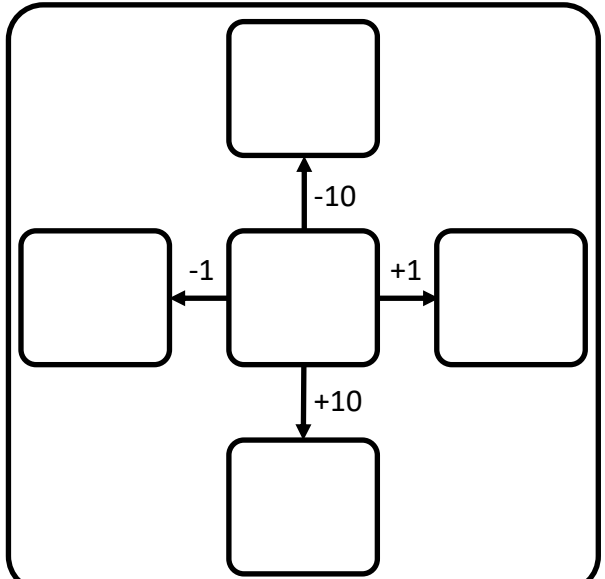
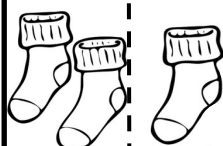

Encadrement sur la frise

C'est notre cent-vingt-neuvième jour de classe.

129 .

$$129 = \dots + \dots + \dots$$



Centaine Dizaines Unités

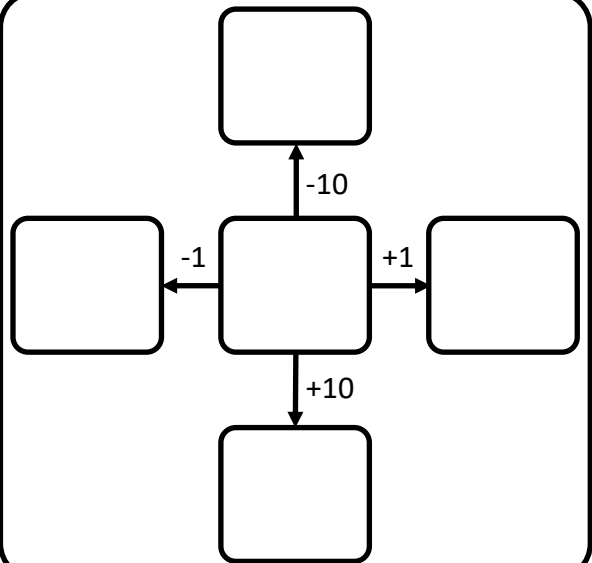
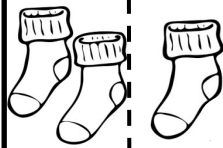

0 10 20 30 40 50 60 70 80 90 100 110 120 130 140 150

www.fabricole.fr

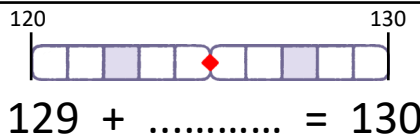

Encadrement sur la frise

.....

C'est notre cent-trentième jour de classe.

130 .

$$130 = \dots + \dots$$



Centaine Dizaines Unités

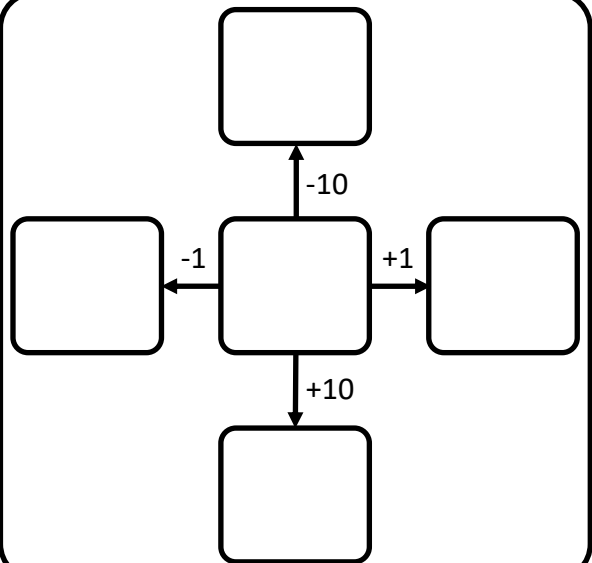
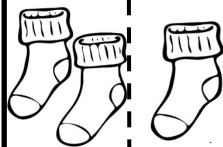

0 10 20 30 40 50 60 70 80 90 100 110 120 130 140 150

www.fabricole.fr

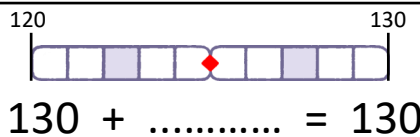

Encadrement sur la frise

.....

C'est notre cent-trente-et-unième jour de classe.

131 .

$$131 = \dots + \dots + \dots$$



Centaine Dizaines Unités

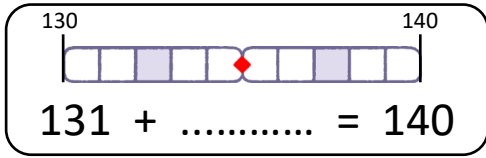
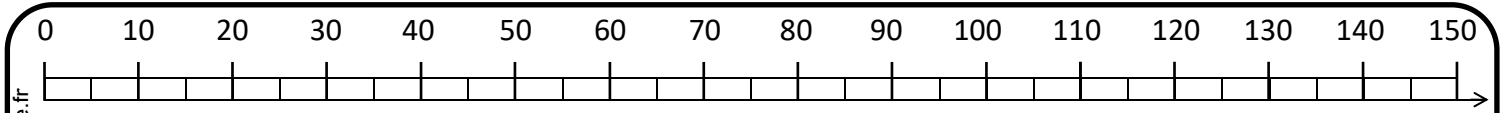
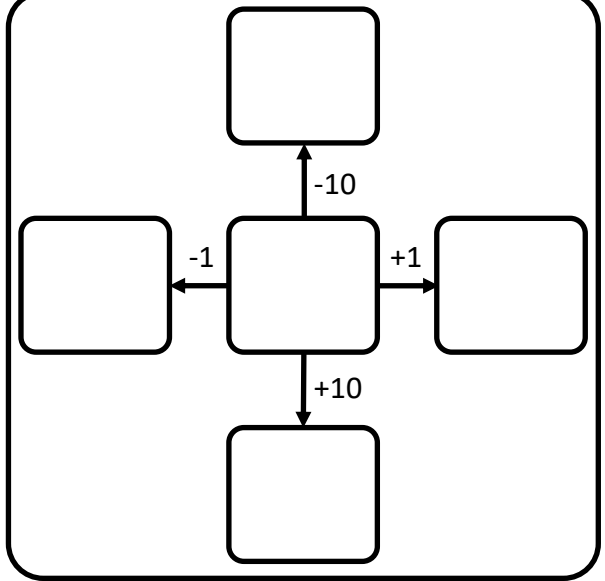
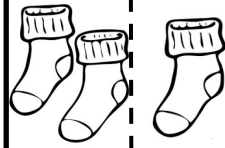

Encadrement sur la frise

.....

C'est notre cent-trente-deuxième jour de classe.

132 .

$$132 = \dots + \dots + \dots$$



Centaine Dizaines Unités

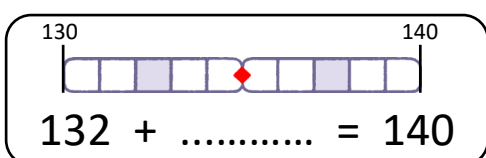
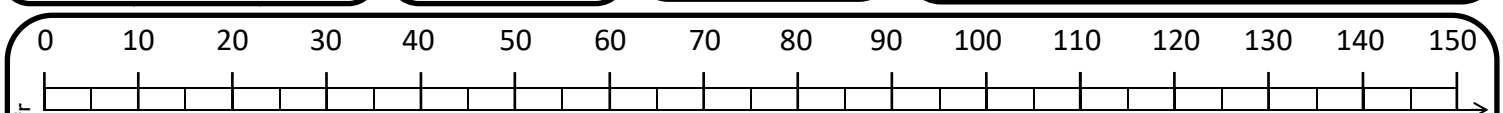
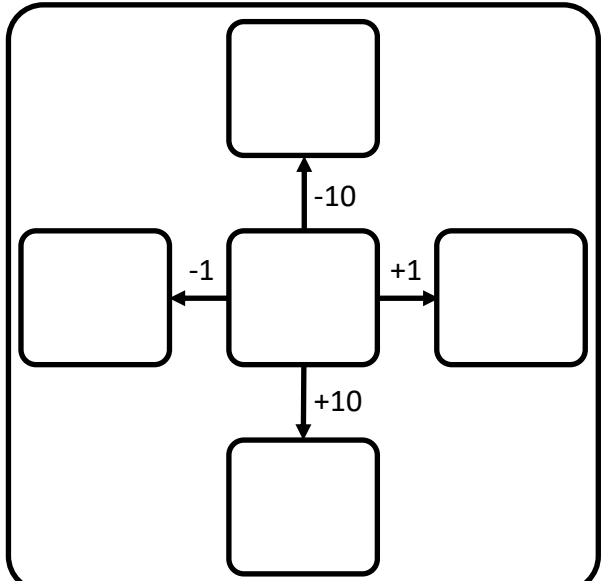
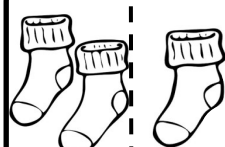

Encadrement sur la frise

.....

C'est notre cent-trente-troisième jour de classe.

133 .

$$133 = \dots + \dots + \dots$$



Centaine Dizaines Unités

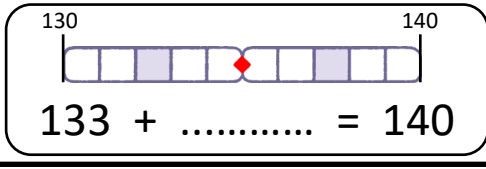
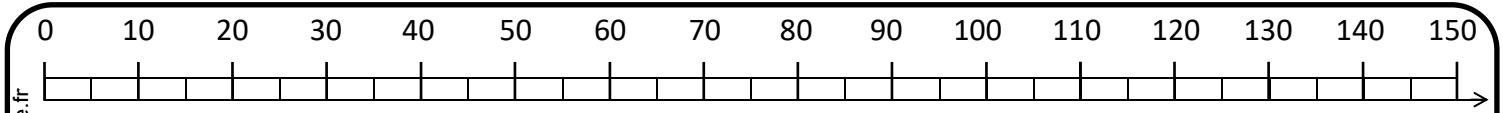
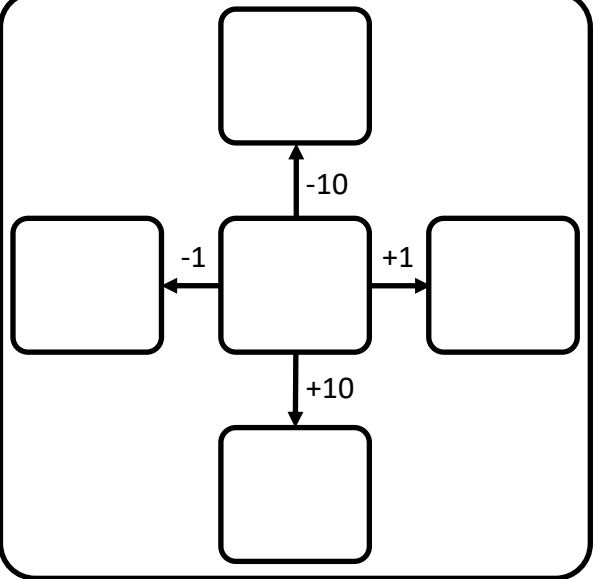
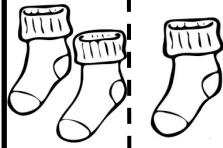

Encadrement sur la frise

.....

C'est notre cent-trente-quatrième jour de classe.

134 .

$$134 = \dots + \dots + \dots$$



Centaine Dizaines Unités

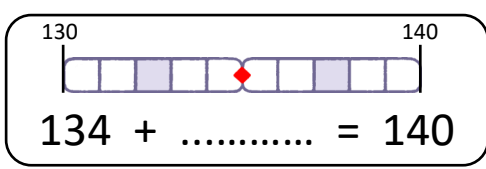
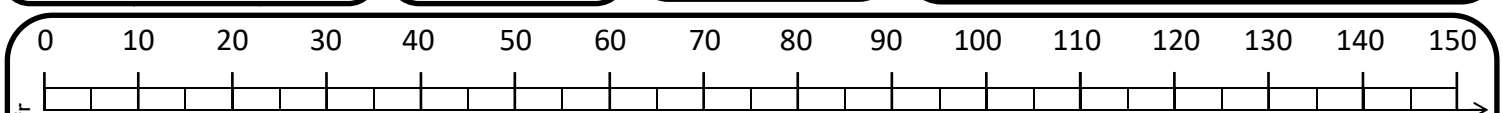
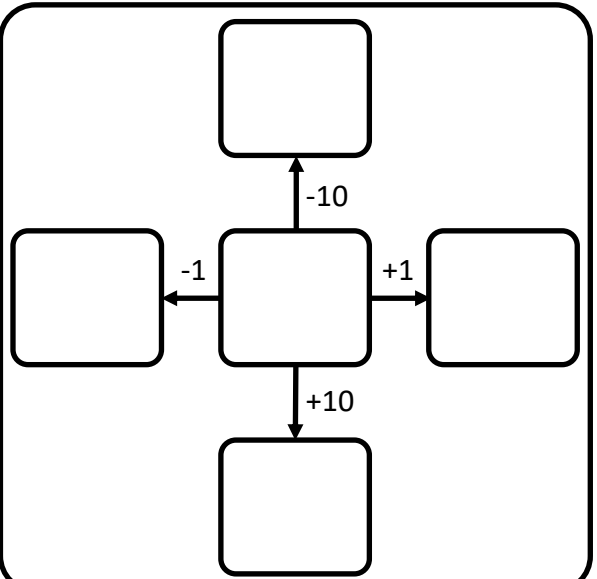

Encadrement sur la frise

.....

C'est notre cent-trente-cinquième jour de classe.

135 .

$$135 = \dots + \dots + \dots$$



Centaine Dizaines Unités

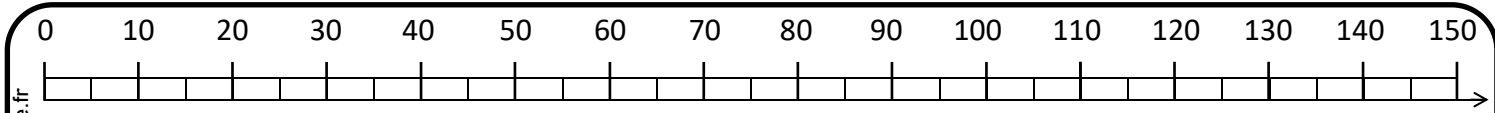
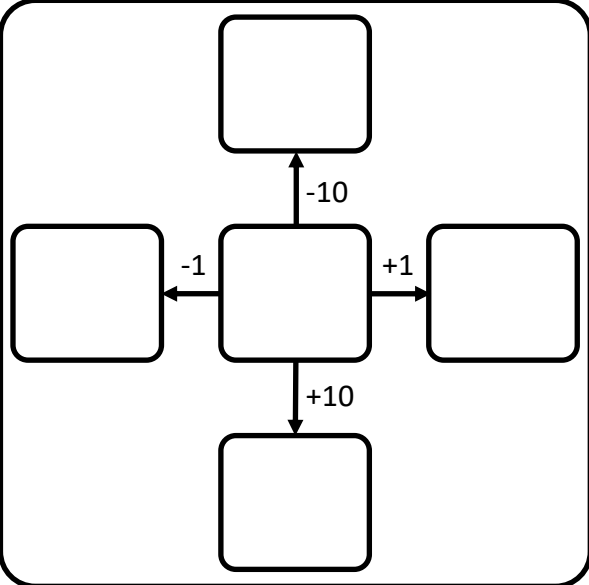
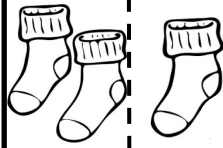

www.fabricole.fr

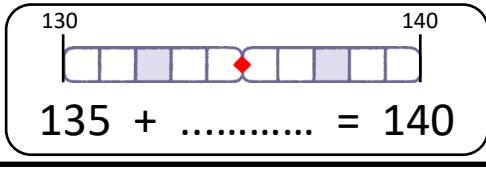

Encadrement sur la frise

.....

C'est notre cent-trente-sixième jour de classe.

136 .

$$136 = \dots + \dots + \dots$$



Centaine Dizaines Unités

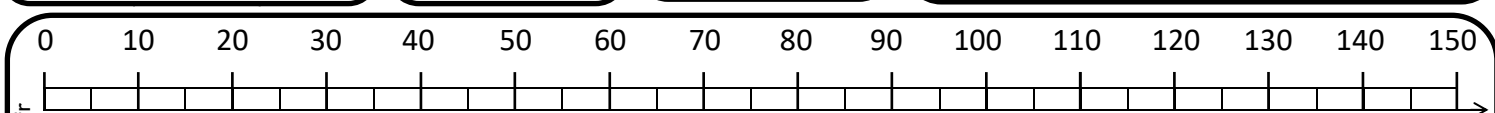
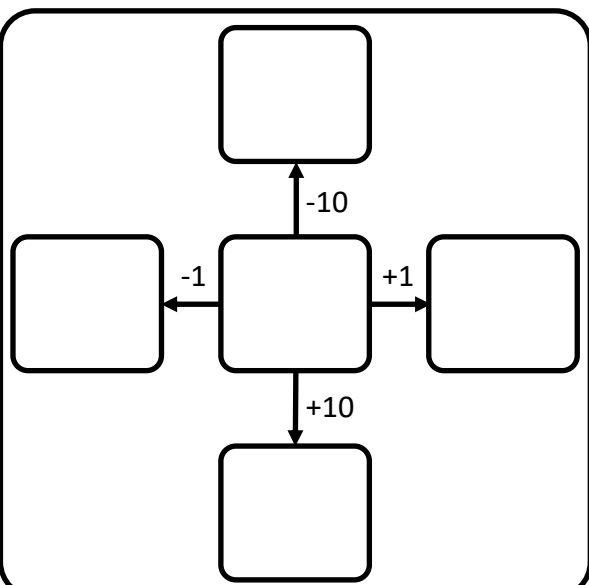
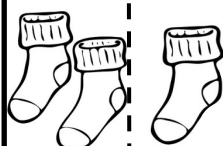

www.fabricole.fr

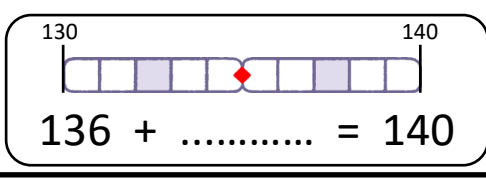

Encadrement sur la frise

.....

C'est notre cent-trente-septième jour de classe.

137 .

$$137 = \dots + \dots + \dots$$



Centaine Dizaines Unités

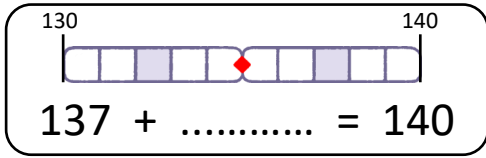
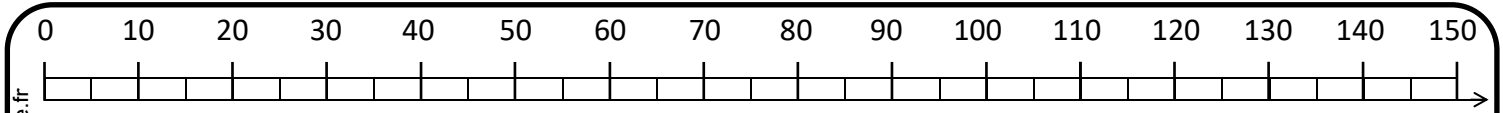
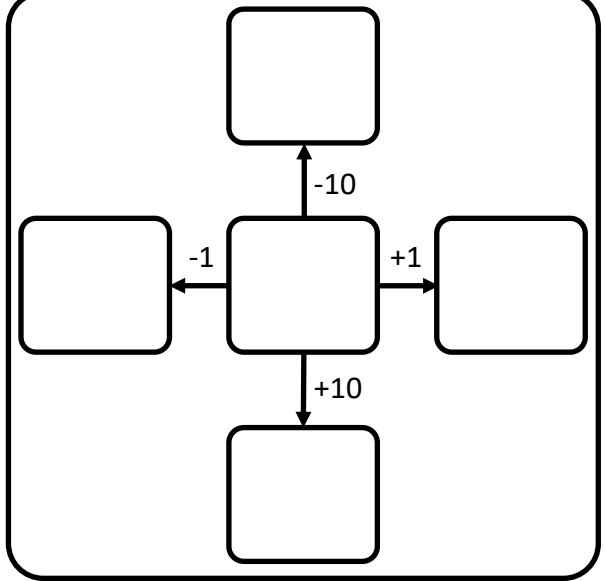
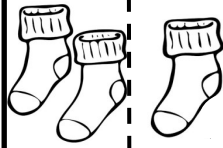

Encadrement sur la frise

C'est notre cent-trente-huitième jour de classe.

138 .

$$138 = \dots + \dots + \dots$$



Centaine Dizaines Unités

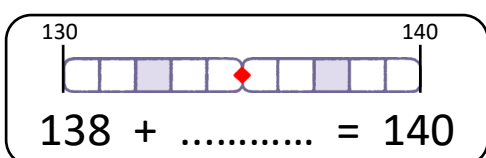
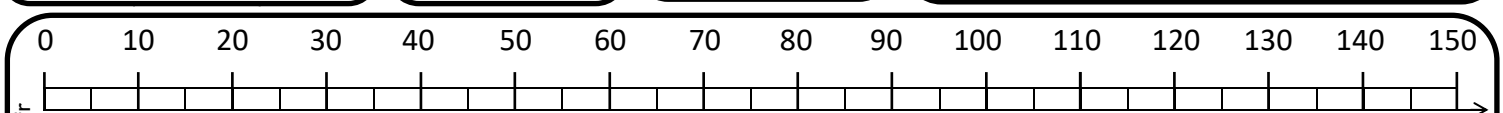
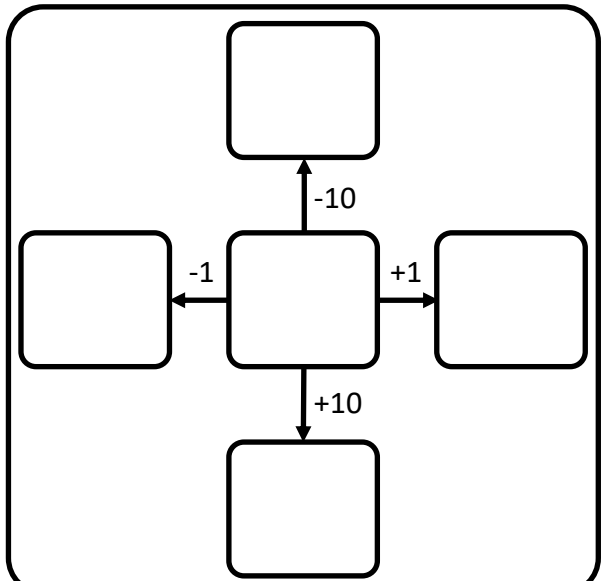

Encadrement sur la frise

C'est notre cent-trente-neuvième jour de classe.

139 .

$$139 = \dots + \dots + \dots$$



Centaine Dizaines Unités

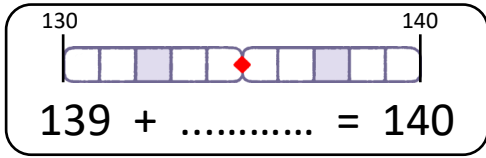
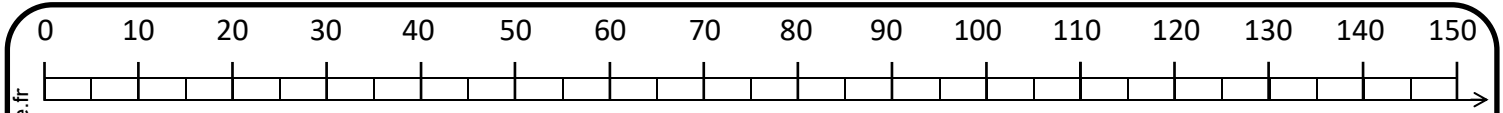
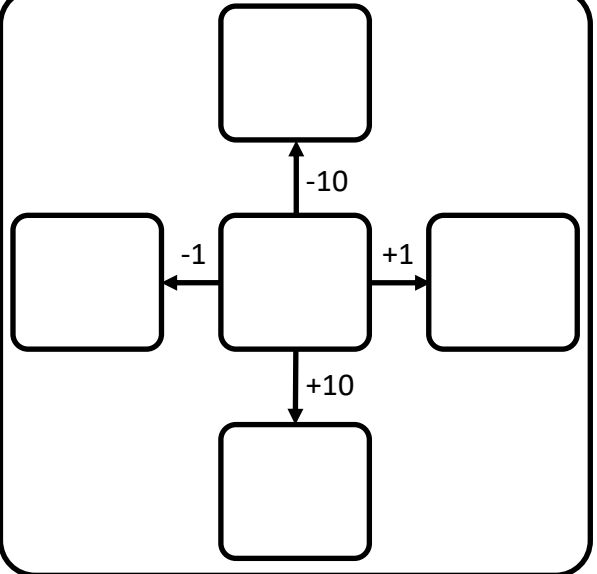
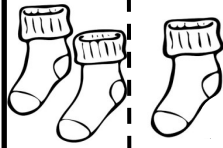

Encadrement sur la frise

C'est notre cent-quarantième jour de classe.

140 .

$$140 = \dots + \dots$$



Centaine Dizaines Unités

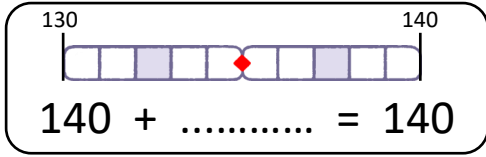
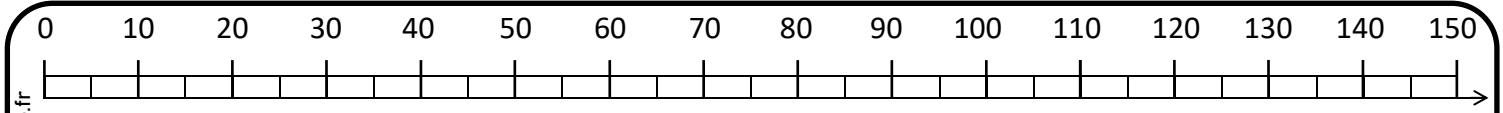
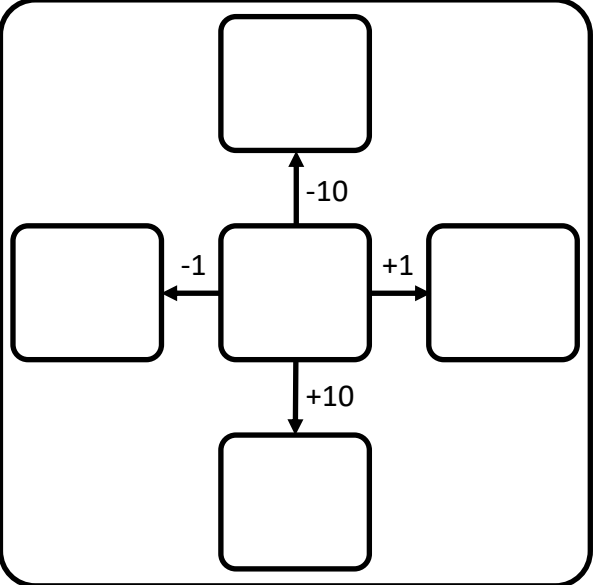

Encadrement sur la frise

C'est notre cent-quarante-et-unième jour de classe.

141 .

$$141 = \dots + \dots + \dots$$



Centaine Dizaines Unités

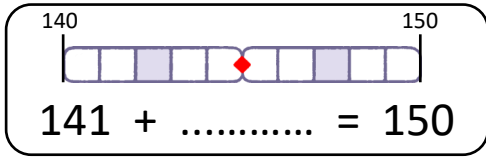
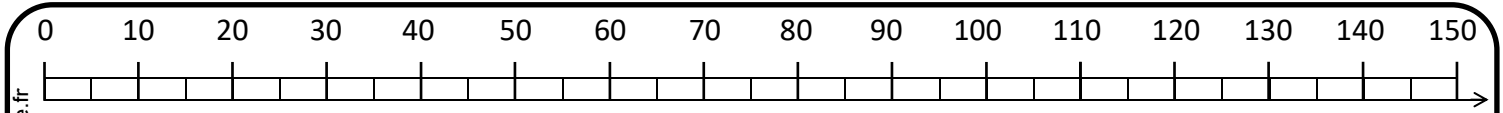
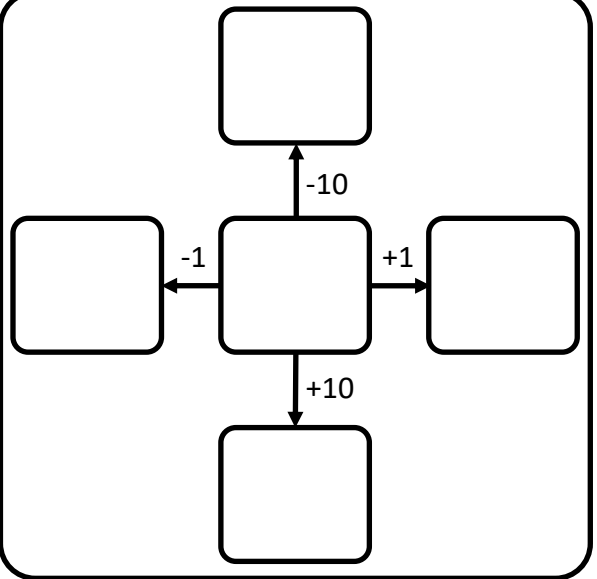
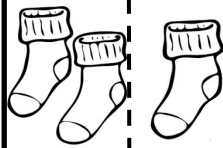

Encadrement sur la frise

C'est notre cent-quarante-deuxième jour de classe.

142 .

$$142 = \dots + \dots + \dots$$



Centaine Dizaines Unités

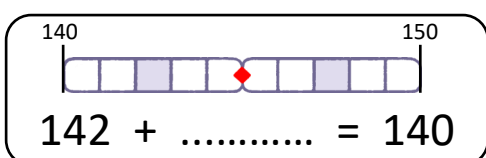
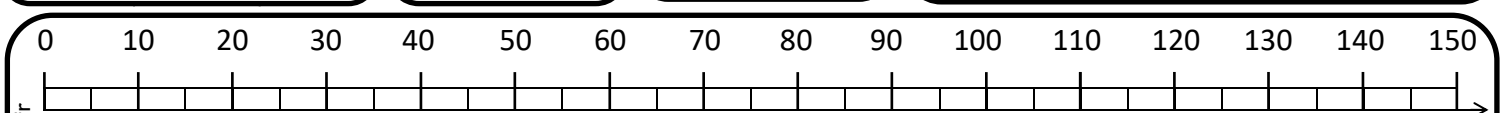
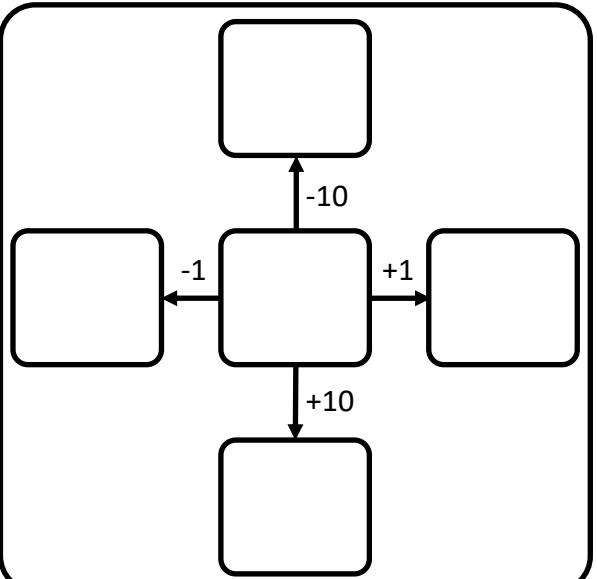

Encadrement sur la frise

C'est notre cent-quarante-troisième jour de classe.

143 .

$$143 = \dots + \dots + \dots$$



Centaine Dizaines Unités

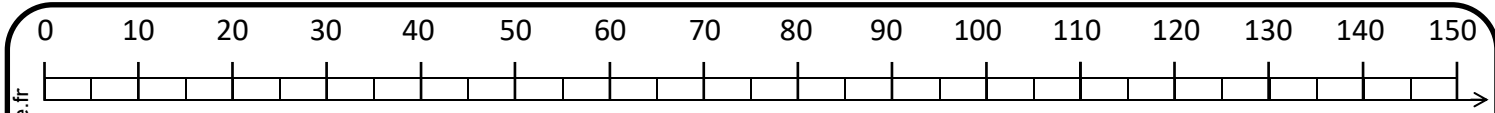
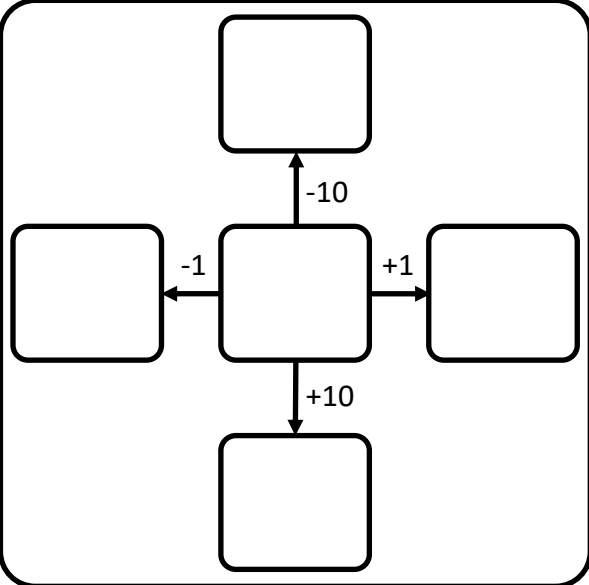
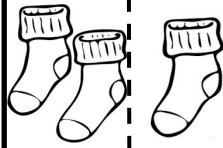

www.fabricole.fr

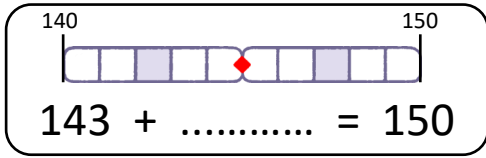

Encadrement sur la frise

.....

C'est notre cent-quarante-quatrième jour de classe.

144 .

$$144 = \dots + \dots + \dots$$



Centaine Dizaines Unités

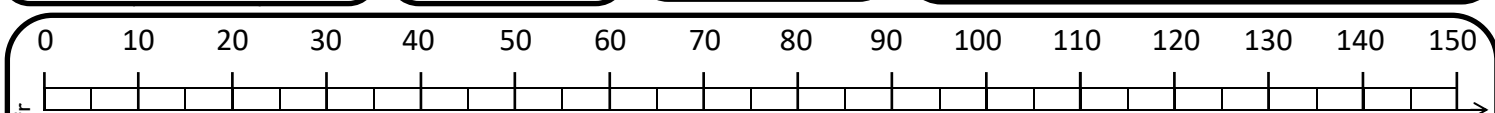
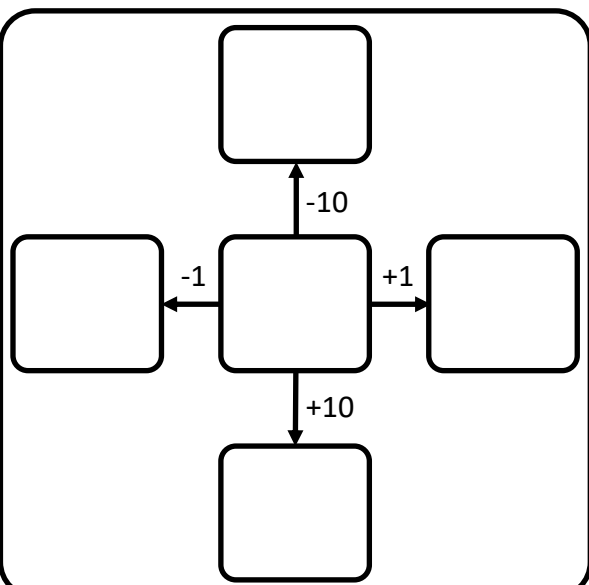

www.fabricole.fr

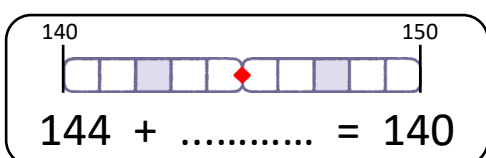

Encadrement sur la frise

.....

C'est notre cent-quarante-cinquième jour de classe.

145 .

$$145 = \dots + \dots + \dots$$



Centaine Dizaines Unités

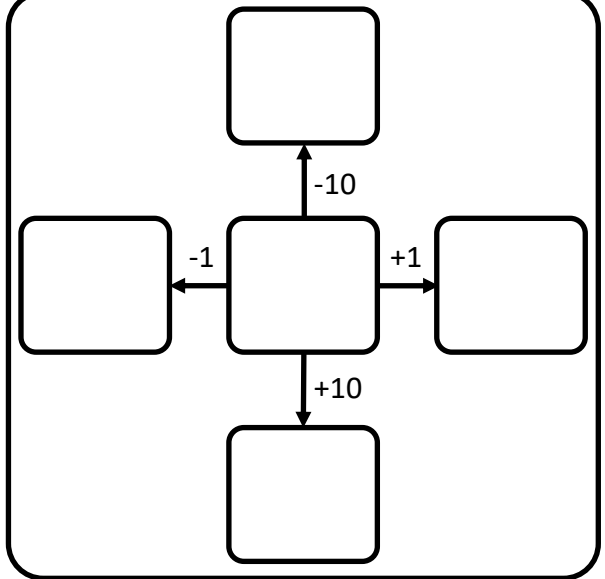
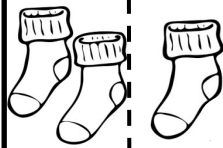

0 10 20 30 40 50 60 70 80 90 100 110 120 130 140 150

www.fabricole.fr

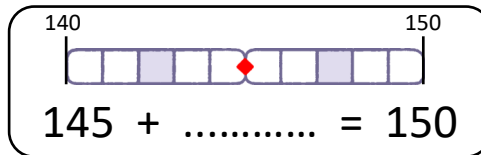

Encadrement sur la frise

.....

C'est notre cent-quarante-sixième jour de classe.

146 .

$$146 = \dots + \dots + \dots$$



Centaine Dizaines Unités

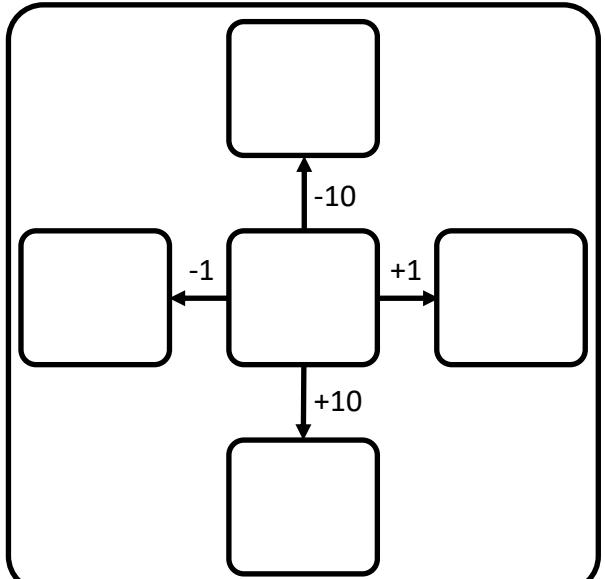
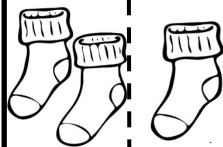

0 10 20 30 40 50 60 70 80 90 100 110 120 130 140 150

www.fabricole.fr

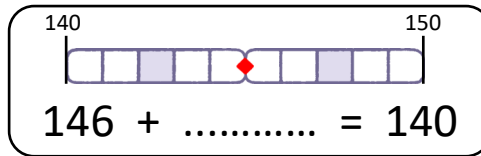

Encadrement sur la frise

.....

C'est notre cent-quarante-septième jour de classe.

147 .

$$147 = \dots + \dots + \dots$$



Centaine Dizaines Unités

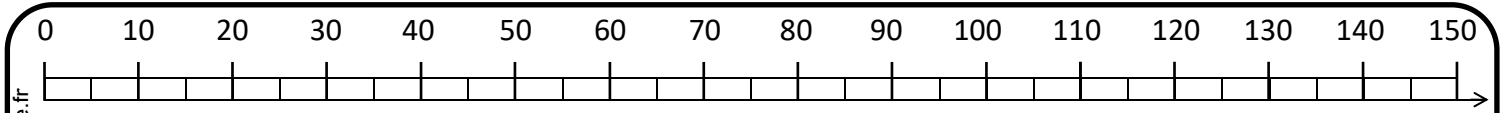
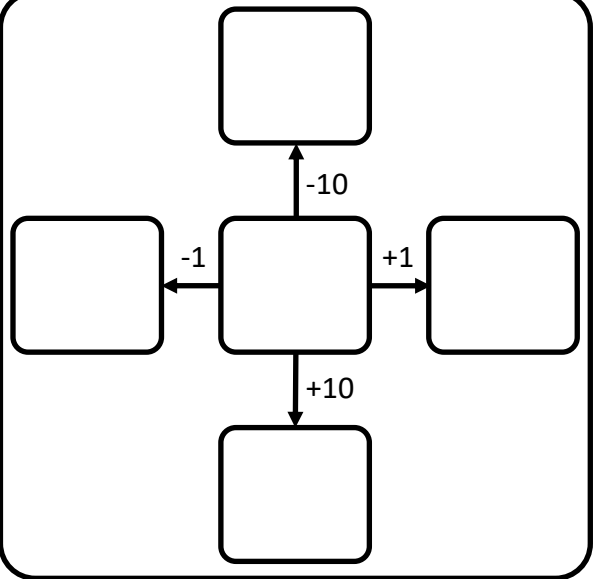
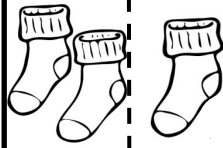

www.fabricole.fr

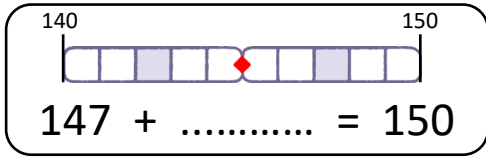

Encadrement sur la frise

.....

C'est notre cent-quarante-huitième jour de classe.

148 .

$$148 = \dots + \dots + \dots$$



Centaine Dizaines Unités

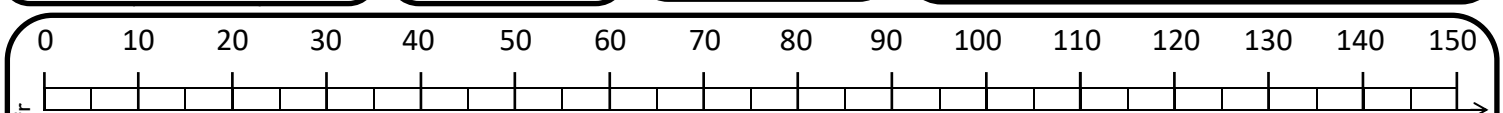
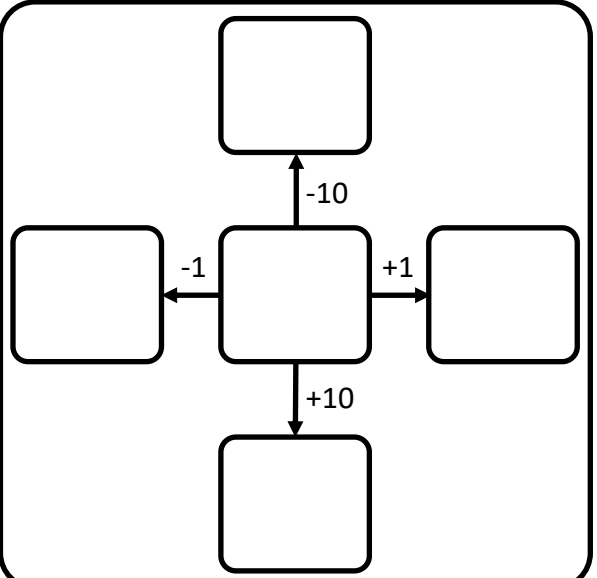

www.fabricole.fr

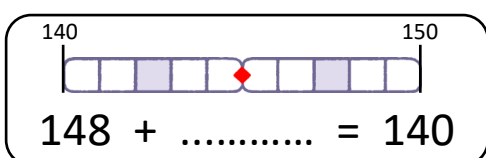

Encadrement sur la frise

.....

C'est notre cent-quarante-neuvième jour de classe.

149 .

$$149 = \dots + \dots + \dots$$



Centaine Dizaines Unités

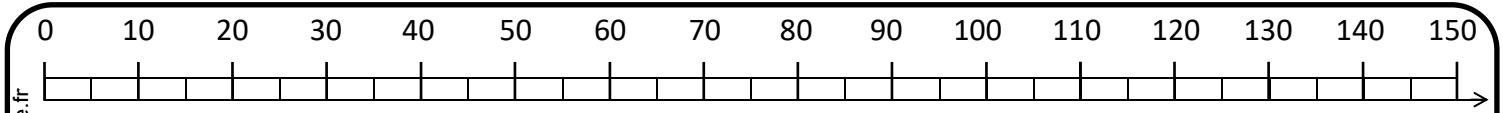
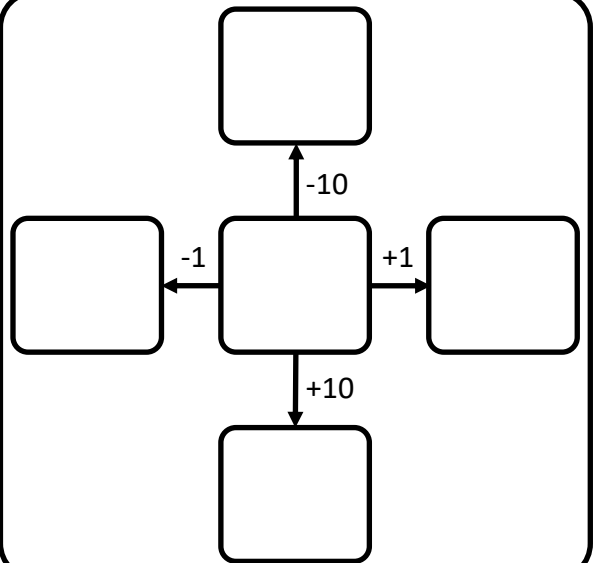
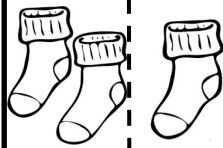

www.fabricole.fr

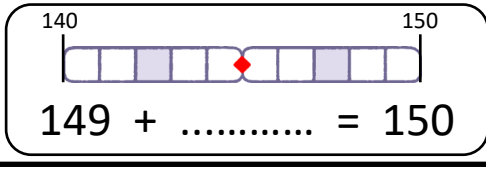

Encadrement sur la frise

C'est notre cent-cinquantième jour de classe.

150 .

$$150 = \dots + \dots$$



Centaine Dizaines Unités

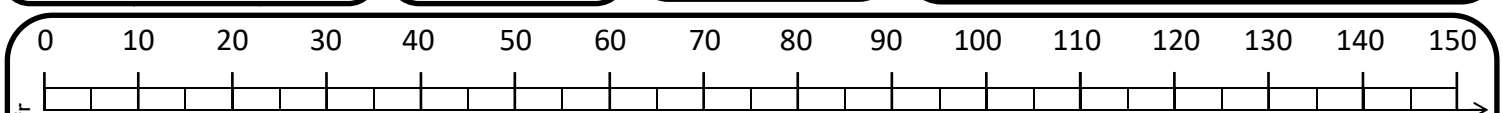
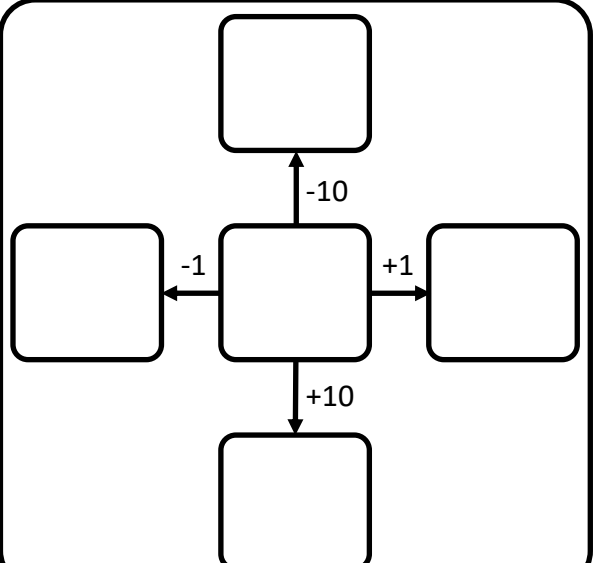
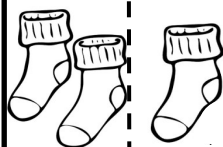

www.fabricole.fr

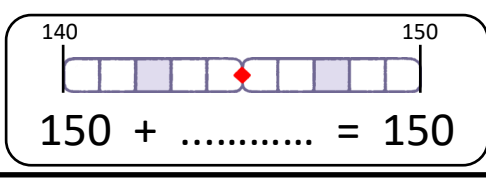

Encadrement sur la frise

C'est notre cent-cinquante-et-unième jour de classe.

151 .

$$151 = \dots + \dots + \dots$$

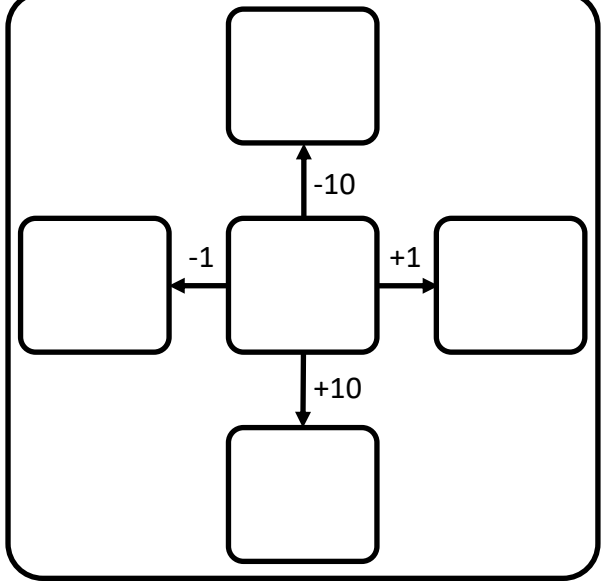

Centaine Dizaines Unités



0 10 20 30 40 50 60 70 80 90 100 110 120 130 140 150 160 170 180 190

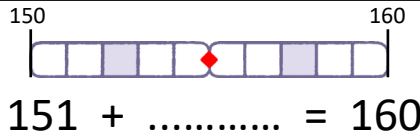

Encadrement sur la frise

C'est notre cent-cinquante-deuxième jour de classe.

152 .

$$152 = \dots + \dots + \dots$$

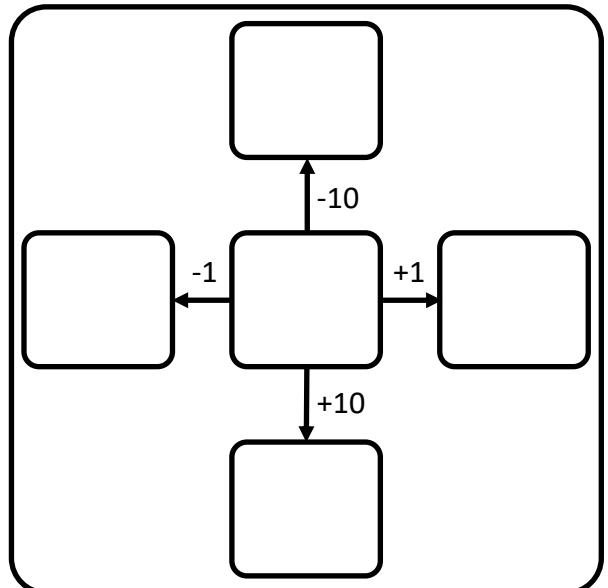

Centaine Dizaines Unités

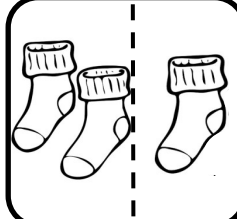

0 10 20 30 40 50 60 70 80 90 100 110 120 130 140 150 160 170 180 190

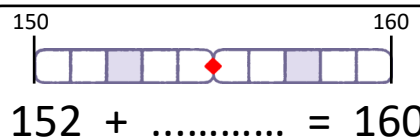

Encadrement sur la frise

C'est notre cent-cinquante-troisième jour de classe.

153 .

$$153 = \dots + \dots + \dots$$

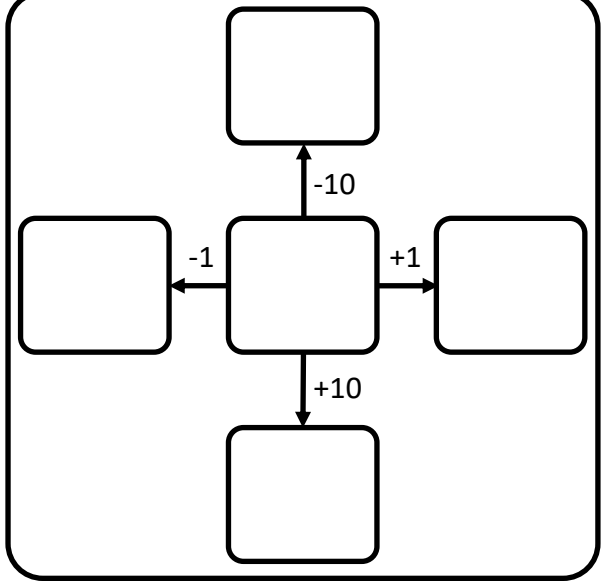

Centaine Dizaines Unités



0 10 20 30 40 50 60 70 80 90 100 110 120 130 140 150 160 170 180 190

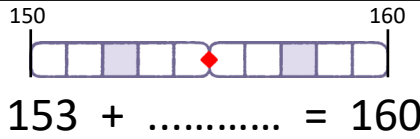

Encadrement sur la frise

C'est notre cent-cinquante-quatrième jour de classe.

154 .

$$154 = \dots + \dots + \dots$$

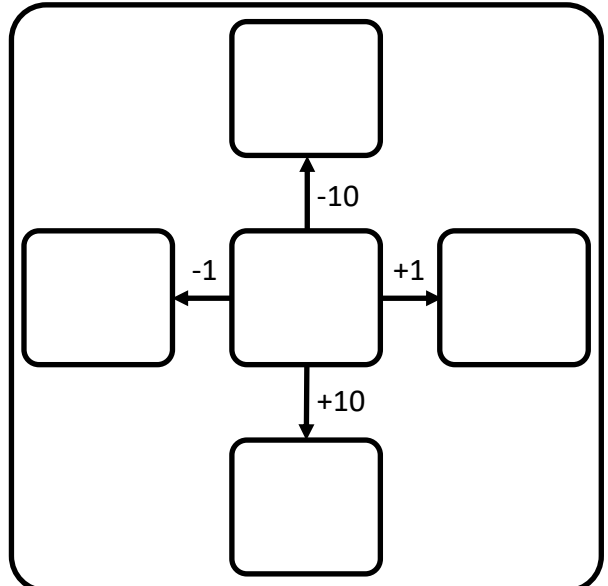

Centaine Dizaines Unités

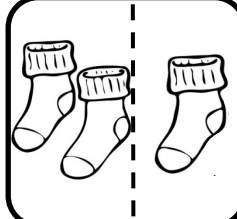

0 10 20 30 40 50 60 70 80 90 100 110 120 130 140 150 160 170 180 190

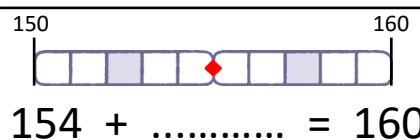

Encadrement sur la frise

C'est notre cent-cinquante-cinquième jour de classe.

155 .

$$155 = \dots + \dots + \dots$$

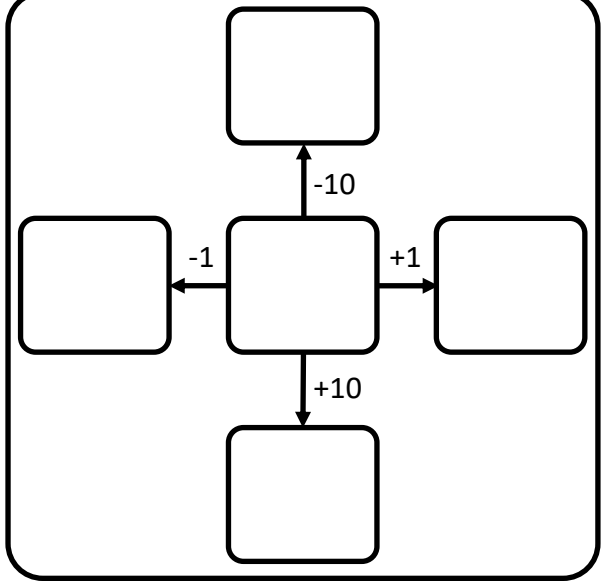

Centaine Dizaines Unités

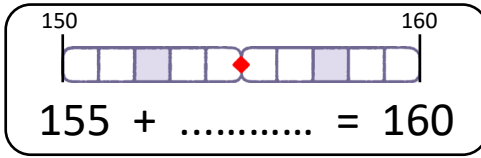
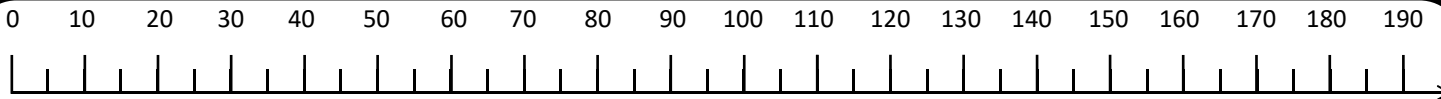

Encadrement sur la frise

C'est notre cent-cinquante-sixième jour de classe.

156 .

$$156 = \dots + \dots + \dots$$

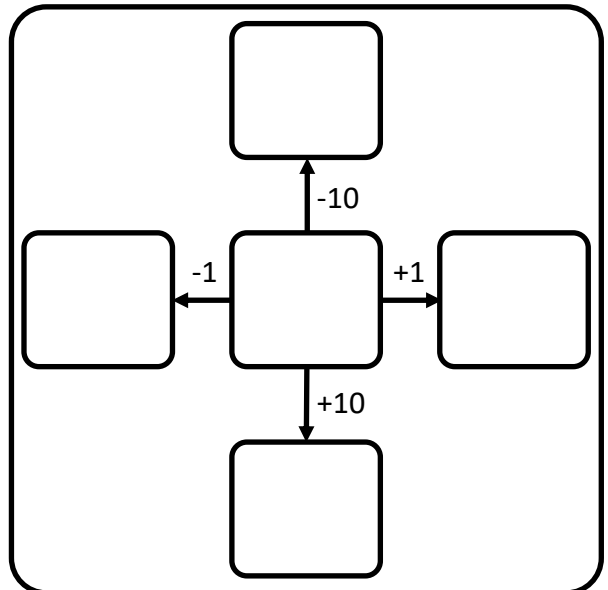

Centaine Dizaines Unités

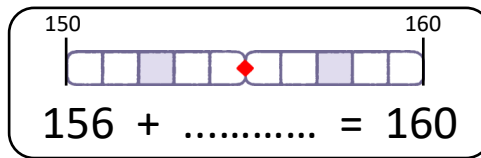
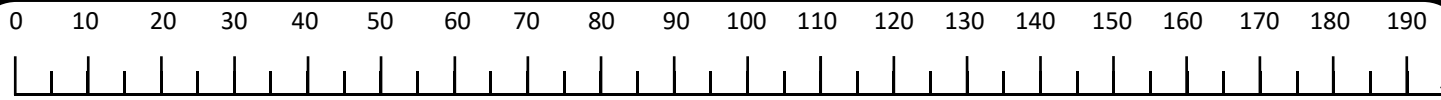
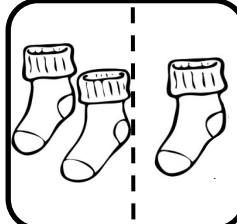

Encadrement sur la frise

C'est notre cent-cinquante-septième jour de classe.

157 .

$$157 = \dots + \dots + \dots$$

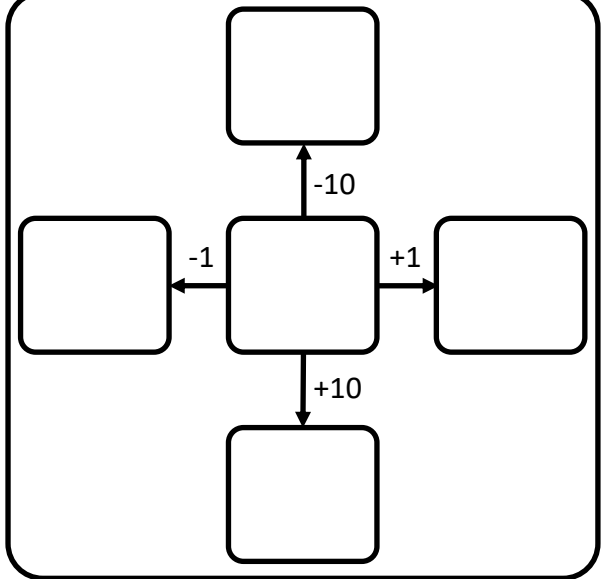

Centaine Dizaines Unités

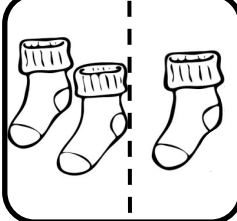

0 10 20 30 40 50 60 70 80 90 100 110 120 130 140 150 160 170 180 190

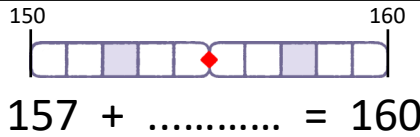

Encadrement sur la frise

C'est notre cent-cinquante-huitième jour de classe.

158 .

$$158 = \dots + \dots + \dots$$

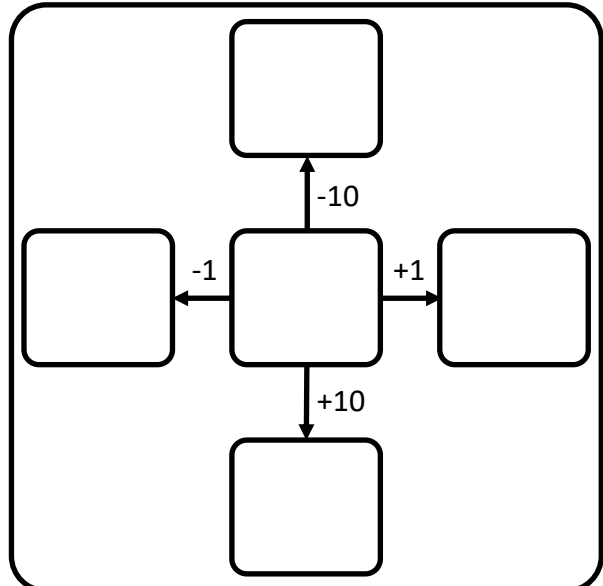

Centaine Dizaines Unités

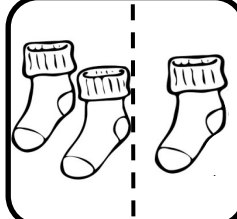

0 10 20 30 40 50 60 70 80 90 100 110 120 130 140 150 160 170 180 190

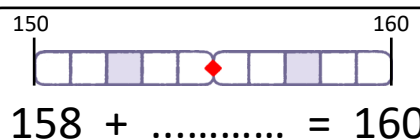

Encadrement sur la frise

C'est notre cent-cinquante-neuvième jour de classe.

159 .

$$159 = \dots + \dots + \dots$$

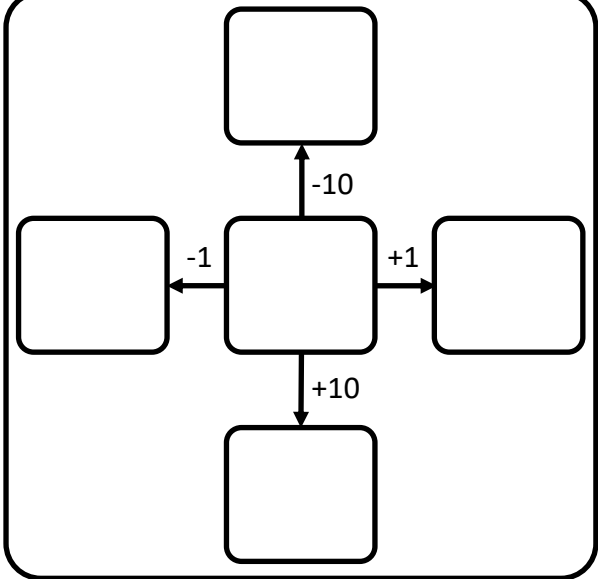

Centaine Dizaines Unités

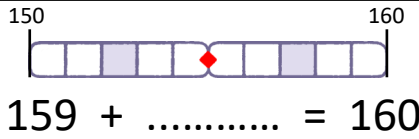
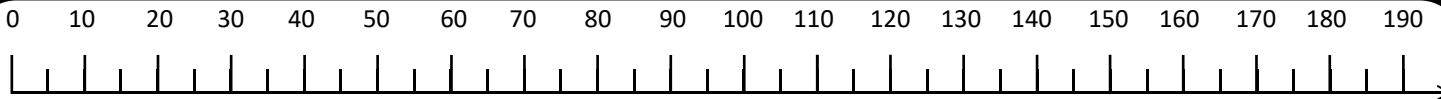
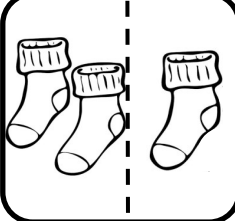

Encadrement sur la frise

C'est notre cent-soixantième jour de classe.

160 .

$$160 = \dots + \dots$$

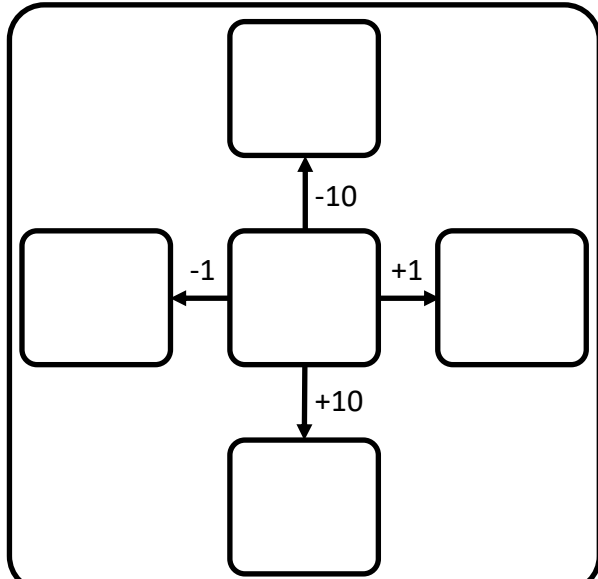

Centaine Dizaines Unités

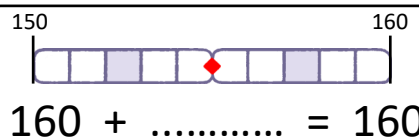
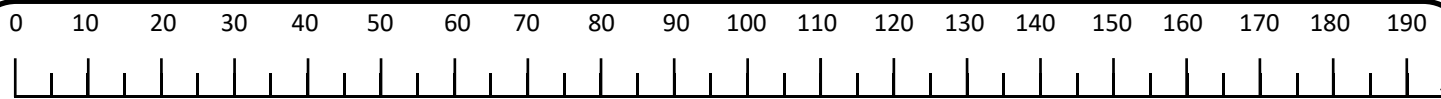
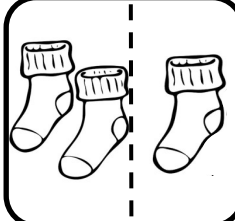

Encadrement sur la frise

C'est notre cent-soixante-et-unième jour de classe.

161 .

$$161 = \dots + \dots + \dots$$

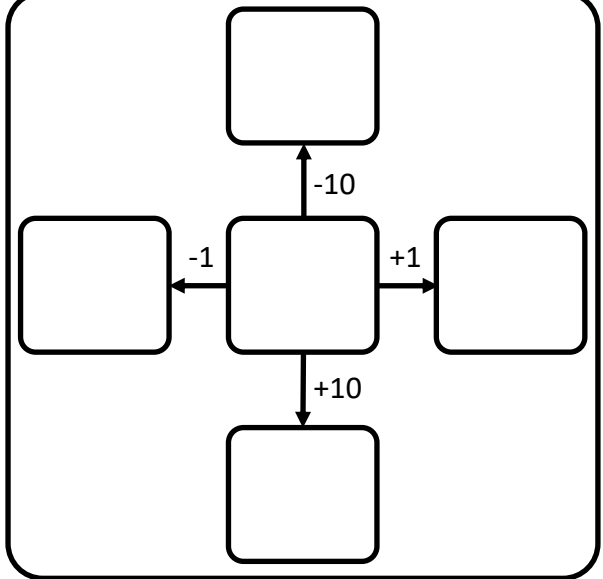

Centaine Dizaines Unités

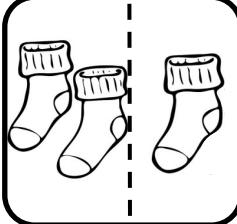

0 10 20 30 40 50 60 70 80 90 100 110 120 130 140 150 160 170 180 190

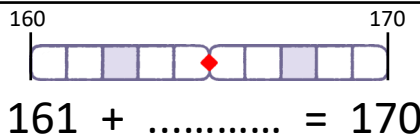

Encadrement sur la frise

C'est notre cent-soixante-deuxième jour de classe.

162 .

$$162 = \dots + \dots + \dots$$

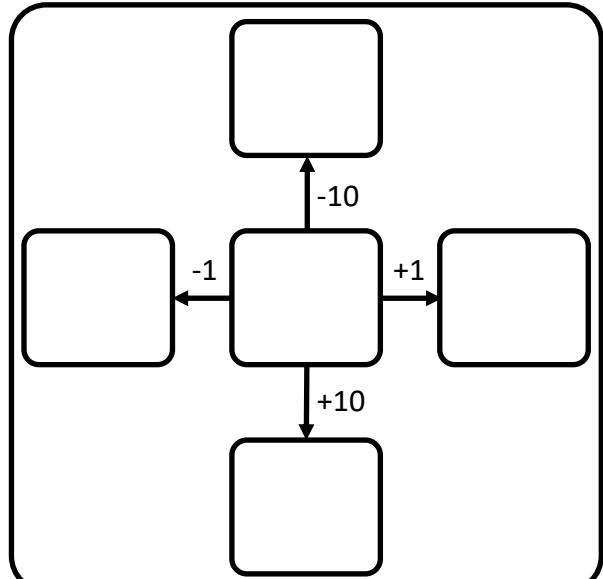

Centaine Dizaines Unités

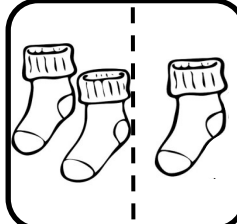

0 10 20 30 40 50 60 70 80 90 100 110 120 130 140 150 160 170 180 190

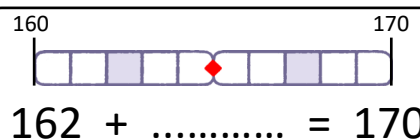

Encadrement sur la frise

C'est notre cent-soixante-troisième jour de classe.

163 .

$$163 = \dots + \dots + \dots$$

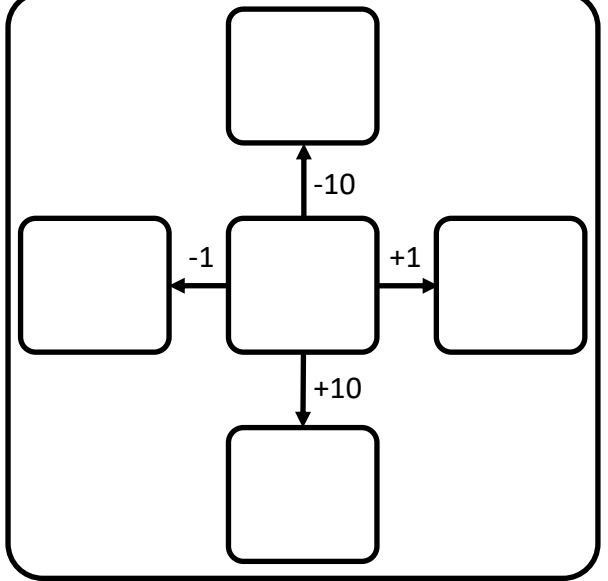

Centaine Dizaines Unités

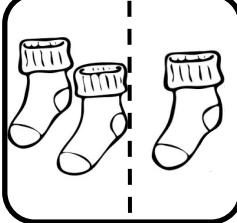

0 10 20 30 40 50 60 70 80 90 100 110 120 130 140 150 160 170 180 190

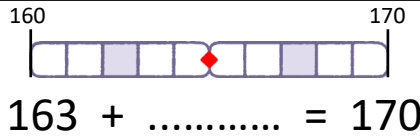

Encadrement sur la frise

$$163 + \dots = 170$$

.....

C'est notre cent-soixante-quatrième jour de classe.

164 .

$$164 = \dots + \dots + \dots$$

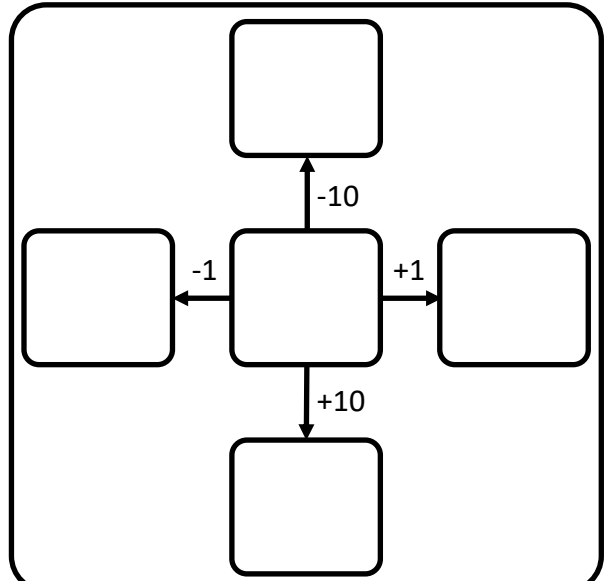

Centaine Dizaines Unités

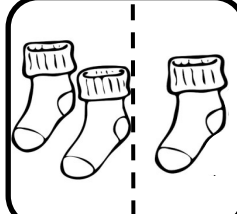

0 10 20 30 40 50 60 70 80 90 100 110 120 130 140 150 160 170 180 190

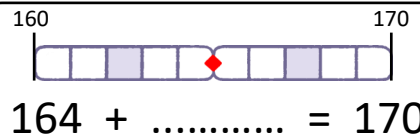

Encadrement sur la frise

$$164 + \dots = 170$$

.....

C'est notre cent-soixante-cinquième jour de classe.

165 .

$$165 = \dots + \dots + \dots$$



Centaine Dizaines Unités

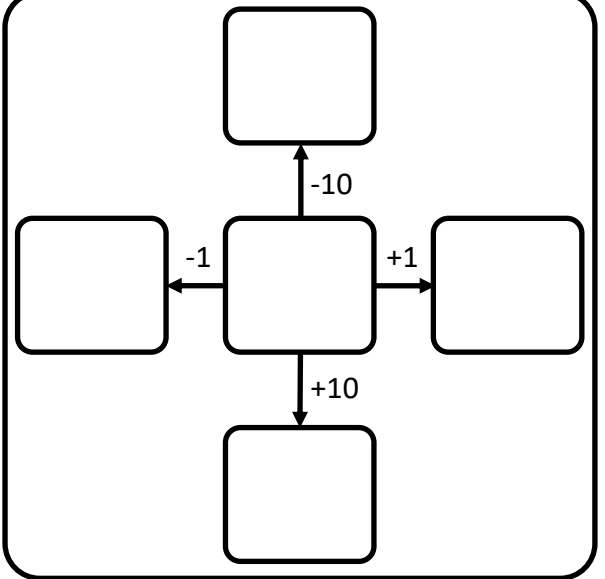
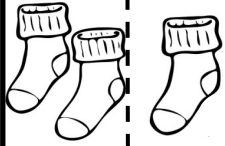

0 10 20 30 40 50 60 70 80 90 100 110 120 130 140 150 160 170 180 190

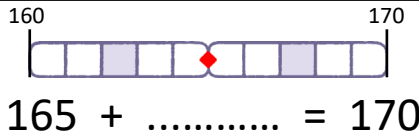

Encadrement sur la frise

C'est notre cent-soixante-sixième jour de classe.

166 .

$$166 = \dots + \dots + \dots$$



Centaine Dizaines Unités

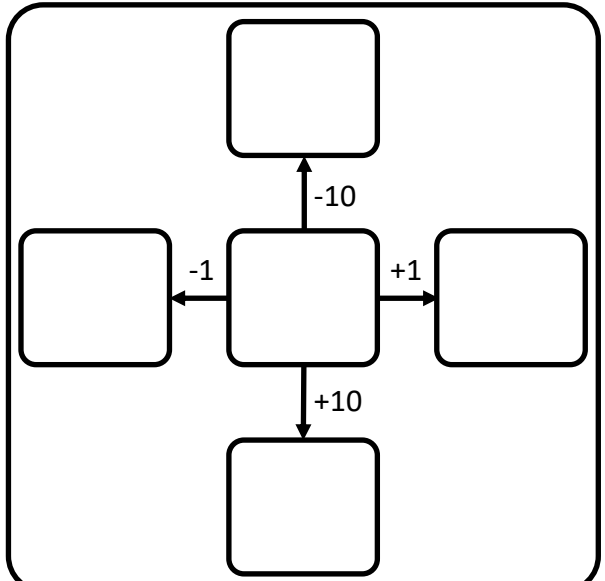
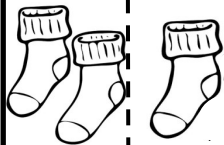

0 10 20 30 40 50 60 70 80 90 100 110 120 130 140 150 160 170 180 190

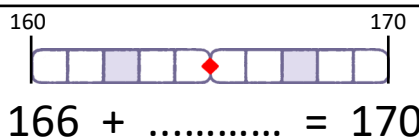

Encadrement sur la frise

C'est notre cent-soixante-septième jour de classe.

167 .

$$167 = \dots + \dots + \dots$$

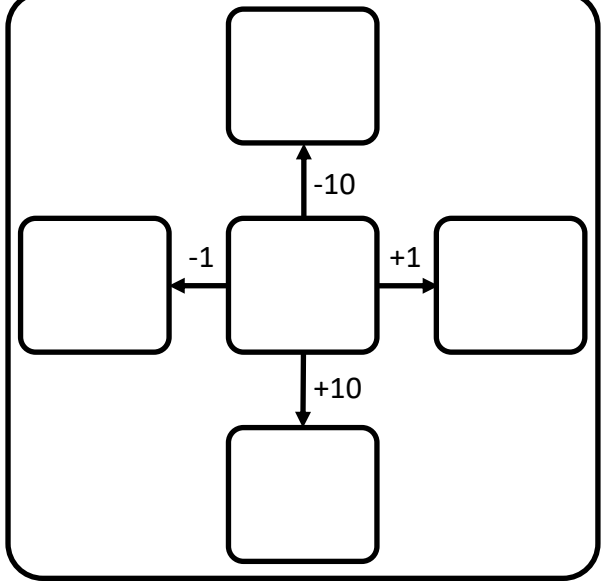

Centaine Dizaines Unités

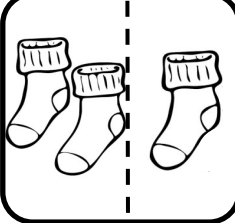

0 10 20 30 40 50 60 70 80 90 100 110 120 130 140 150 160 170 180 190

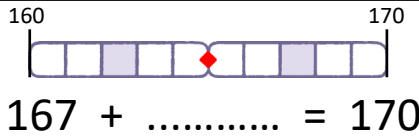

Encadrement sur la frise

$$167 + \dots = 170$$

.....

C'est notre cent-soixante-huitième jour de classe.

168 .

$$168 = \dots + \dots + \dots$$

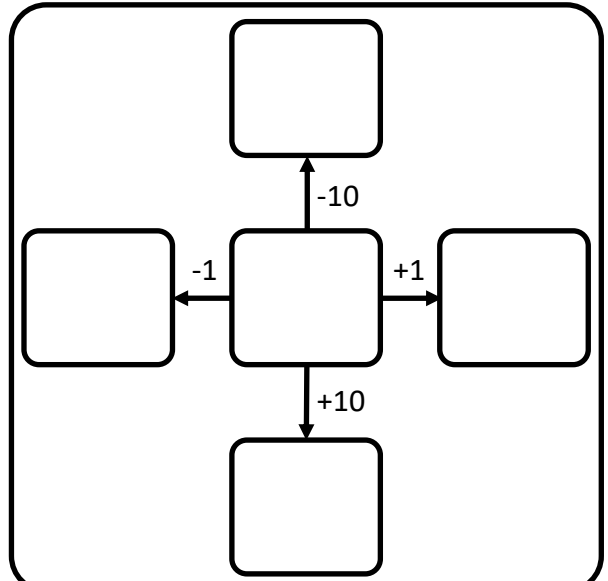

Centaine Dizaines Unités

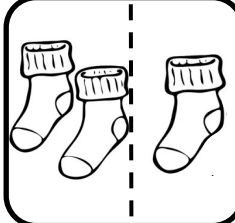

0 10 20 30 40 50 60 70 80 90 100 110 120 130 140 150 160 170 180 190

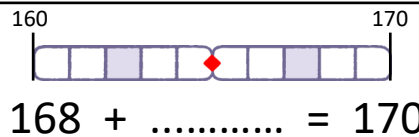

Encadrement sur la frise

$$168 + \dots = 170$$

.....

C'est notre cent-soixante-neuvième jour de classe.

169 .

$$169 = \dots + \dots + \dots$$



Centaine Dizaines Unités

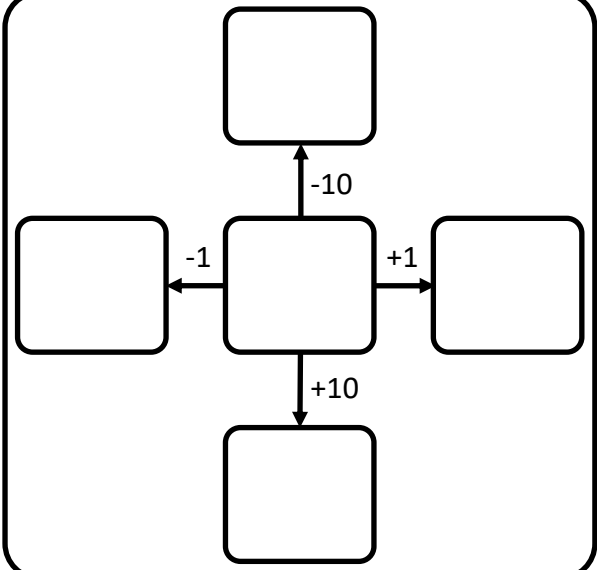
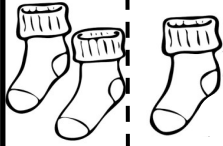

0 10 20 30 40 50 60 70 80 90 100 110 120 130 140 150 160 170 180 190

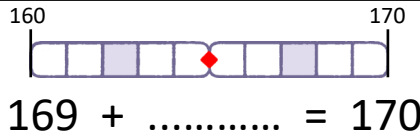

Encadrement sur la frise

$$169 + \dots = 170$$

.....

C'est notre cent-soixante-dixième jour de classe.

170 .

$$170 = \dots + \dots$$



Centaine Dizaines Unités

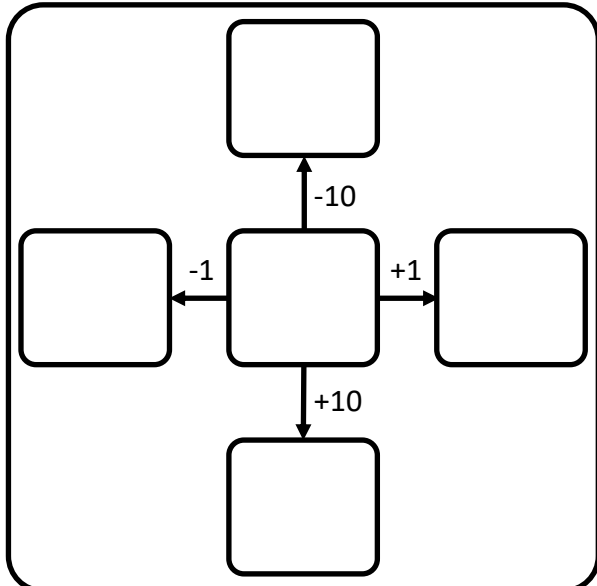
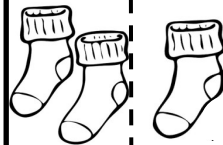

0 10 20 30 40 50 60 70 80 90 100 110 120 130 140 150 160 170 180 190

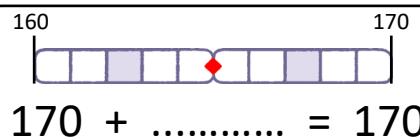

Encadrement sur la frise

$$170 + \dots = 170$$

.....

C'est notre cent-soixante-et-onzième jour de classe.

171 .

$$171 = \dots + \dots + \dots$$

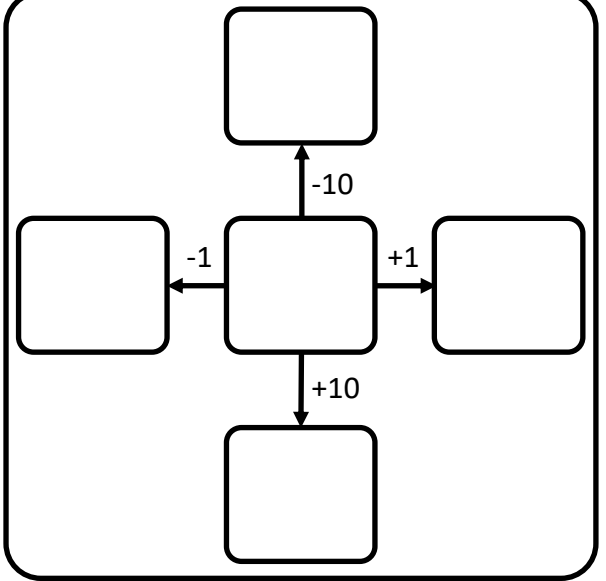

Centaine Dizaines Unités

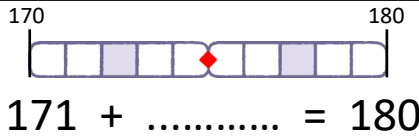
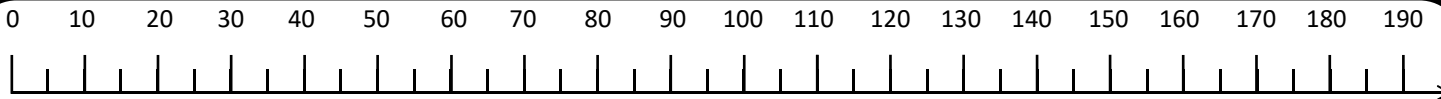

Encadrement sur la frise

C'est notre cent-soixante-douzième jour de classe.

172 .

$$172 = \dots + \dots + \dots$$

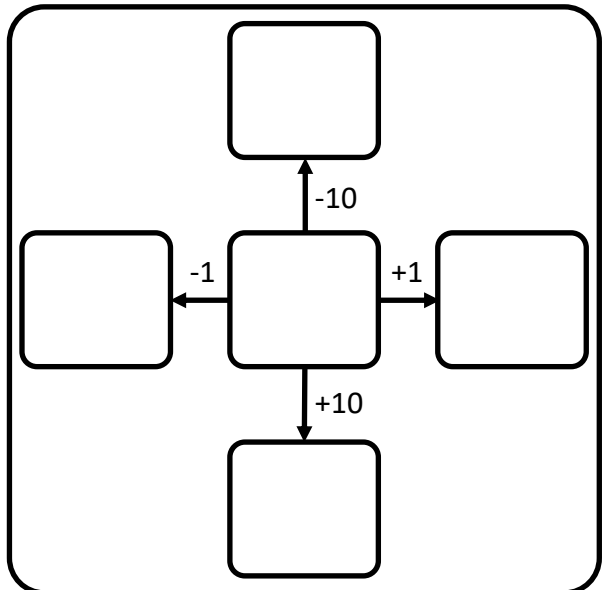

Centaine Dizaines Unités

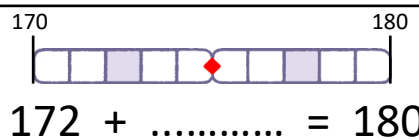
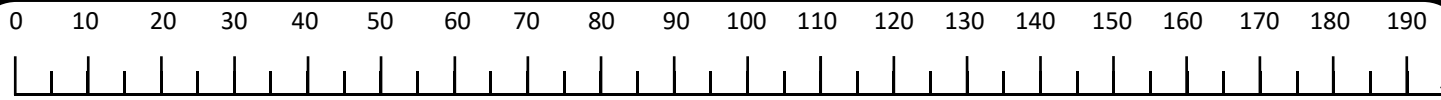
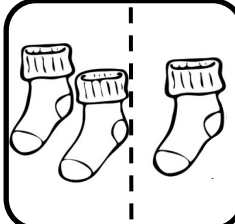

Encadrement sur la frise

C'est notre cent-soixante-treizième jour de classe.

173 .

$$173 = \dots + \dots + \dots$$

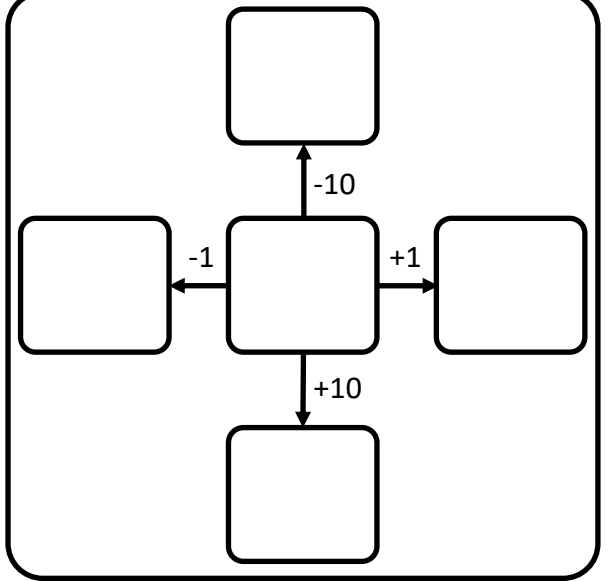

Centaine Dizaines Unités

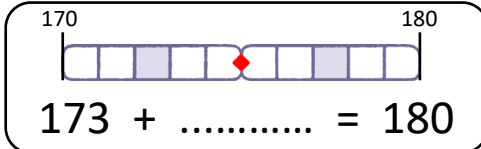
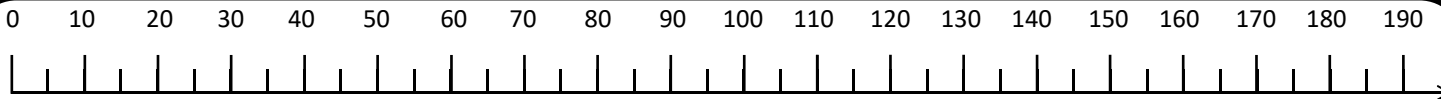

Encadrement sur la frise

C'est notre cent-soixante-quatorzième jour de classe.

174 .

$$174 = \dots + \dots + \dots$$

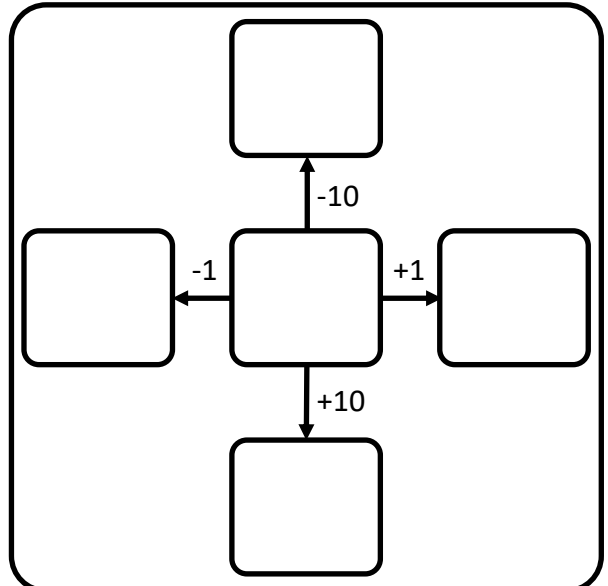

Centaine Dizaines Unités

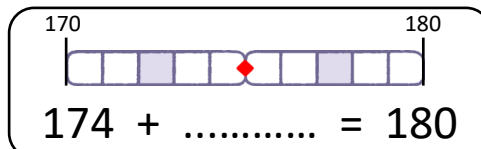
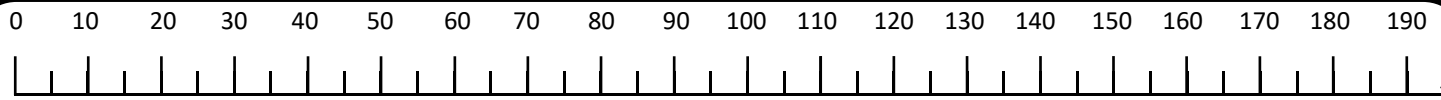
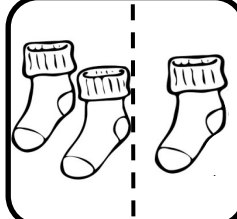

Encadrement sur la frise

C'est notre cent-soixante-quinzième jour de classe.

175 .

$$175 = \dots + \dots + \dots$$



Centaine Dizaines Unités

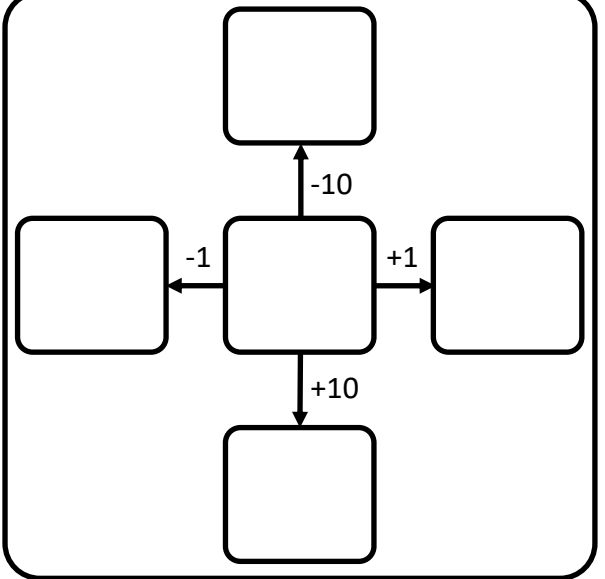
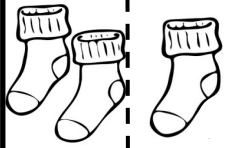

0 10 20 30 40 50 60 70 80 90 100 110 120 130 140 150 160 170 180 190

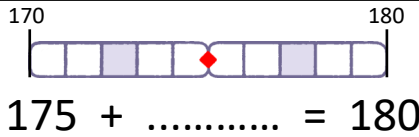

Encadrement sur la frise

$$175 + \dots = 180$$

.....

C'est notre cent-soixante-seizième jour de classe.

176 .

$$176 = \dots + \dots + \dots$$



Centaine Dizaines Unités

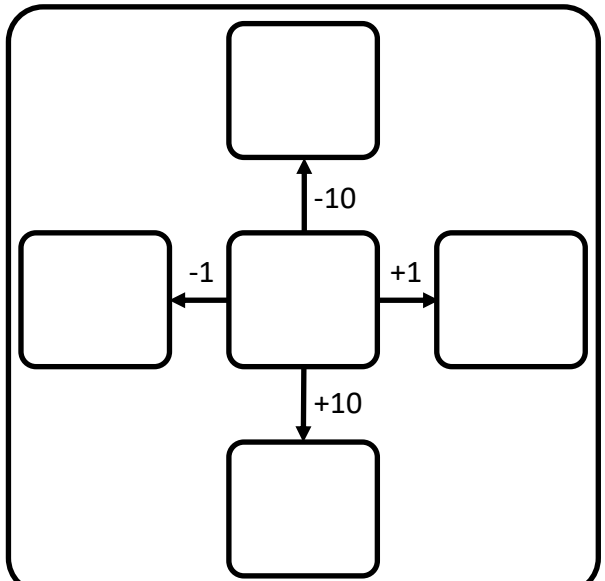
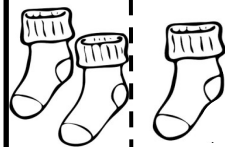

0 10 20 30 40 50 60 70 80 90 100 110 120 130 140 150 160 170 180 190

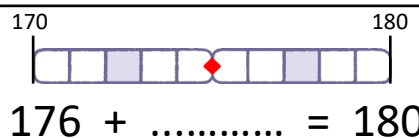

Encadrement sur la frise

$$176 + \dots = 180$$

.....

C'est notre cent-soixante-dix-septième jour de classe.

177 .

$$177 = \dots + \dots + \dots$$



Centaine Dizaines Unités

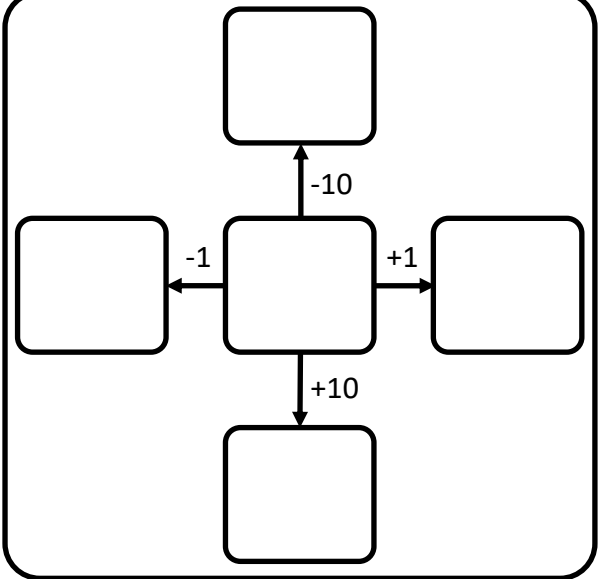
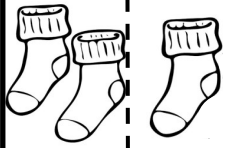

0 10 20 30 40 50 60 70 80 90 100 110 120 130 140 150 160 170 180 190

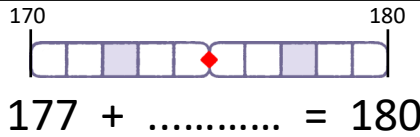

Encadrement sur la frise

C'est notre cent-soixante-dix-huitième jour de classe.

178 .

$$178 = \dots + \dots + \dots$$



Centaine Dizaines Unités

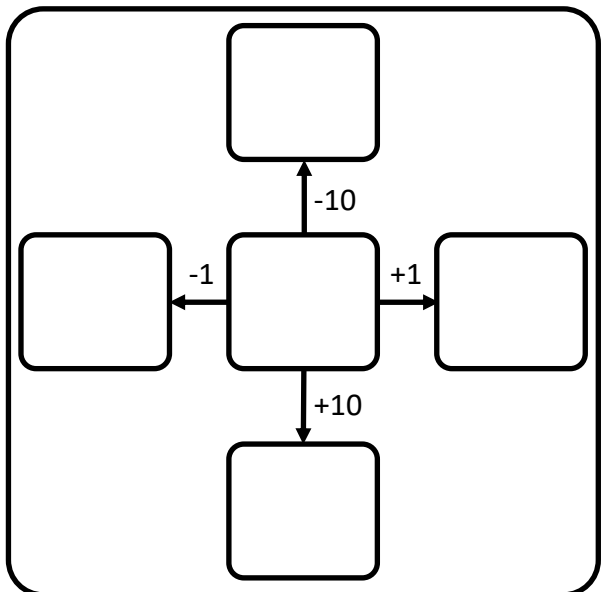
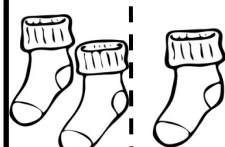

0 10 20 30 40 50 60 70 80 90 100 110 120 130 140 150 160 170 180 190

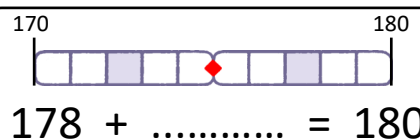

Encadrement sur la frise

C'est notre cent-soixante-dix-neuvième jour de classe.

179 .

179 = + +

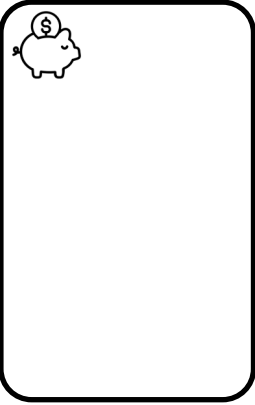

Centaine	Dizaines	Unités

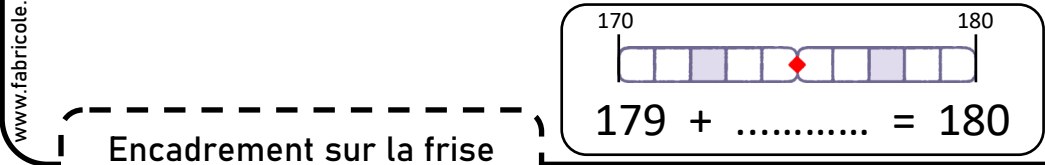
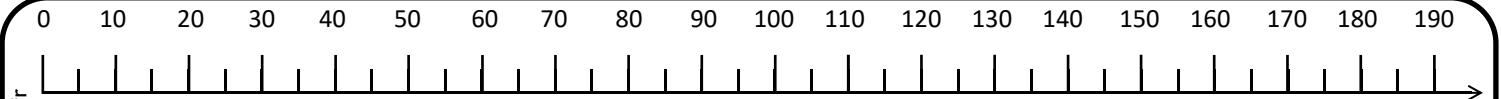
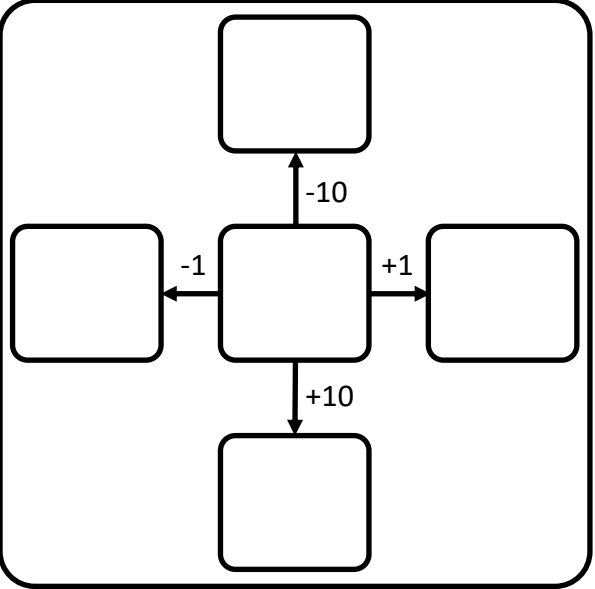

Encadrement sur la frise

.....

C'est notre cent-quatre-vingtième jour de classe.

180 .

180 = +

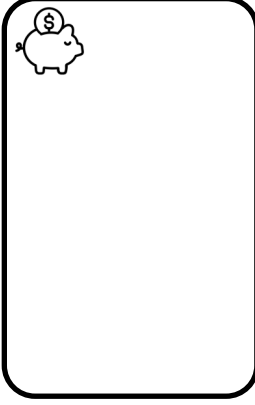

Centaine	Dizaines	Unités

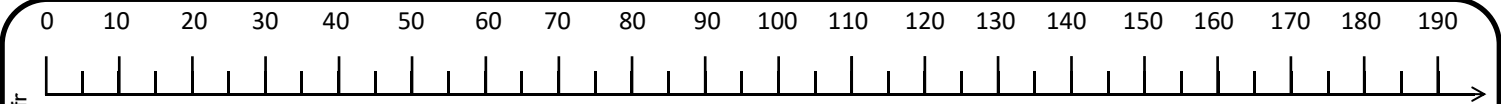
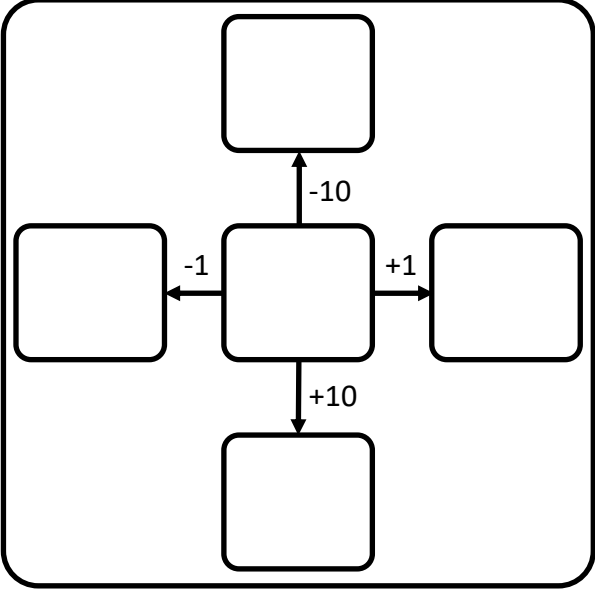
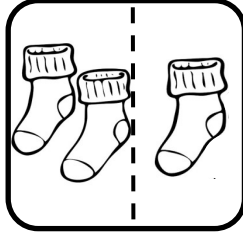

Encadrement sur la frise

.....